

# Portugal Ventures

GROWING GLOBAL

GRUPO **BP**



START **YOUR VENTURE** WITH US

# Big Numbers

Our Universe



170

MILLIONS OF EUROS UNDER MANAGEMENT



+147

NEW COMPANIES since 2012



164

MILLIONS OF EUROS INVESTED since 2012

# How We Invest



We favour co-investment with **PORTUGUESE AND INTERNATIONAL PARTNERS**



We hold a **MINORITY STAKE** in the company's share capital



**TICKETS BETWEEN 50K€ AND 1.500K€** depending on the sector and stage



**TRANCHE PAYMENTS** usually made as each milestone is achieved



We typically have a **SEAT** on the company's Board of Directors

# Investment Strategy

Sectors



DIGITAL

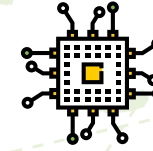

ENGINEERING & MANUFACTURING

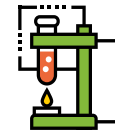

LIFE SCIENCES



TOURISM



Location

STARTUPS WITH REGISTERED OFFICES IN PORTUGAL



Stages

- PRE-SEED
- SEED
- SERIES A





# Portfolio

Digital



41  
COMPANIES



71.6  
MILLION EUROS  
INVESTED

since 2012 - new investments and follow-ons

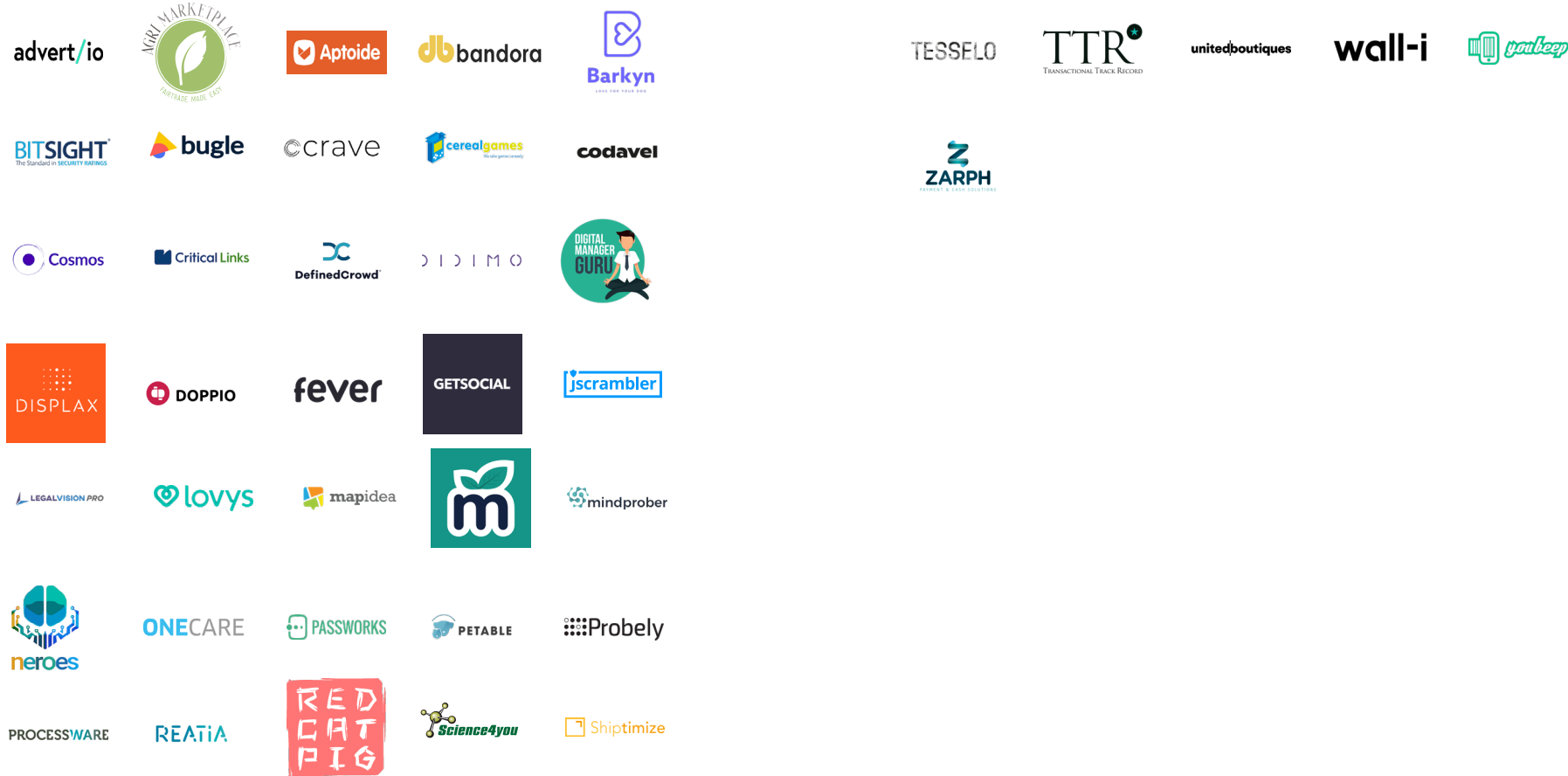

# Portfolio

Digital



41  
COMPANIES



71.6  
MILLION EUROS  
INVESTED

since 2012 - new investments and follow-ons



## ACHIEVE YOUR ADVERTISING GOALS MORE EFFICIENTLY

### Big Idea

Advert.io helps small advertisers reach new customers more effectively through advertising, automating the digital advertising process. It automatically creates, tailors and distributes campaigns, based on the information collected from its customer's website. Advertio's algorithm optimises return on investment in digital advertising by distributing ads on multiple platforms, such as social media, search engines and blog networks.

# advert/io



### Sector

Technology, Media and Telecommunications

### Activity Highlights

Google Premier Partner

### Team

[Joao Aroso](#) - CEO & Co-Founder

[Pedro Rodrigues](#) - CTO & Co-Founder



## A B2B DIGITAL PLATFORM WHERE FAIR GOOD TRADE IS MADE EASY, FAST AND TRANSPARENT

### Big Idea

Agri Marketplace is a digital platform for buying and selling agricultural food crops that promotes direct negotiation between farmers and the agro industry. The business model aims to promote fair trade and transparency in the food supply chain by eliminating the costs of traditional intermediation. At the same time, it ensures access to value added services, such as distribution and logistics, offering producers and buyers access to and the ability to negotiate in a truly global market, transposing the barriers of local markets with less cost. Selling and buying agricultural products is made easier through the marketing, sales, logistics and certification tools the platform provides, as well as rigorous market research and a 100% secure payment system. The Agri Marketplace is, thus, the alternative to boosting agricultural business.



### Sector

AgroTech

### Team

[Tiago Pessoa](#) - CEO

[Filipe Nuncio](#) - Founder

[Luís Silva](#) - Founder

[José Eduardo Magalhães](#) - Founder

## The Independent Android App Store

Discover and distribute top apps in the safest Android app store. No geo-restrictions so that you can find all the content you want, wherever you want.

INSTALL NOW!

KNOW MORE



### THE INDEPENDENT ANDROID APP STORE.

#### Big Idea

Aptoide is the game-changing alternative Android app store. With over 200 million users worldwide, over 6 billion downloads and 1 million apps, Aptoide gives a new meaning to the way we discover and install apps. Through social collaboration, tailored recommendations and the opportunity to create and share your own store, Aptoide is revolutionising app distribution. Aptoide gives developers, OEMs and telecommunication companies access to a fully customisable app store and a worldwide competitive revenue share model. With an ever-growing community and a solid number of partnerships, Aptoide is now on one of the leading players in the apps world.



**Sector**  
Mobile

#### Team

[Paulo Trezentos](#) - CEO & Co-Founder

[Álvaro Pinto](#) - COO & Co-Founder



### EMPOWERING AUTONOMOUS BUILDING OPERATIONS WITH AI

#### Big Idea

Bandora is a virtual facility manager 24/7 dedicated to well operate and maintain your commercial building! Bandora integrates with any existent IoT systems, so we do not overlap, but complement the current investments! We push commercial buildings to operate to their utmost efficiency, keep spaces well ventilated and healthy, look for the optimal comfort zone for the occupants and detect abnormal consumptions, in order to reduce unexpected downtimes and stop wasting energy.



**Sector**  
Digital

#### Activity Highlights

Bold Ideas Innovation'18 Challenge da Schneider Electric – top 30;  
Proptech Challenge'18 – Top 25;  
Innovation Station Auchan'18 – WildCard;  
EEPA'18 winner;  
MINI URBAN-X national finalist'20;  
Lift Labs COMCAST finalist'21 – Top5.

#### Team

[Márcia Pereira](#) – CEO  
[Ricardo Gomes](#)



## CUSTOMISED NUTRITION AND HEALTH FOR YOUR DOG

### Big Idea

Barkyn is a subscription service for pets that combines personalized food and a remote vet. It's already a strong online brand, operating in Portugal, Spain and Italy, in a high growth vertical. Barkyn brings innovation to the pet market with technology and own products but also to e-commerce with a personalized experience.



**Sector**  
eCommerce

### Team

[André Jordão](#) - CEO & Co-Founder



## MAKING DATA-DRIVEN DECISIONS TO REDUCE CYBER RISK WITH THE WORLD'S LEADING SECURITY RATINGS PLATFORM

### Big Idea

BitSight is the most widely sought Security Ratings company and its mission is to change the way the world addresses cyber risk. Over 1,500 organisations are using the BitSight Security Ratings solution to continuously monitor cyber risk in their business ecosystem. Using an approach similar to credit ratings for financial risk, BitSight customers are able to gain insight into the security posture of third parties as well as their own organisation. BitSight Security Ratings are calculated on a scale of 250-900, with a higher rating indicating better security performance.



**Sector**  
Cybersecurity

### Team

[Stephen Harvey](#) - CEO  
[Nagarjuna Venna](#) - CPO & Co-Founder  
[Stephen Boyer](#) - CTO & Co-Founder  
[Dave Fachetti](#) - EVP of Strategy





## VIDEO TRAINING MADE EASY

### Big Idea

Bugle is an easy to use online video training platform for companies to share training and knowledge with their customers, partners and employees. It helps Marketing, Sales, Operations, Customer Success and other strategic teams achieve better results by using training to onboard and train customers, partners and teams, and to attract and convert leads. By offering customer education in an academy available 24/7 in any device, our customers can improve crucial metrics such as increase product usage and adoption, reduce churn, improve customer satisfaction and loyalty, increase revenue, reduce operational costs and so on. Bugle's Digital Learning Solutions team helps customers create their training courses from turnkey to light consultancy solutions.



### Sector

Education and Human Resources

### Activity highlights

- 2015 - EdTech 20 Finalist
- 2018 - Great User Experience Award from Finances Online
- 2018 - Rising Star Award for Learning Management System from Finances Online

### Team

- [João Ferro Rodrigues](#) - Founder & CEO
- [Ana Luísa Morgado](#) - Head of Digital Learning Solutions
- [Joana Fonseca](#) - Head of Marketing
- [Francisca Cordeiro](#) - Head of Customer Success
- [Rodrigo Pessoa Jorge](#) - Business Development Manager
- [Leandro Maringolo](#) - CTO
- [Carina Leal](#) - Product Development Manager



## INSPIRING CIRCULAR LIFESTYLE CONTENT

### Big Idea

Crave is a circular lifestyle content and ecommerce platform. We accelerate the impact and business success of circular brands, focusing on waste-based and zero-waste products in the home, fashion, and lifestyle categories. We promote a circular lifestyle through inspiring and educational content.



### Sector

Digital

### Activity Highlights

- Jury Prize from C boot, a circular-pre-startup coaching program
- Finalist for the Santa Casa Challenge 2020
- Rise for impact 2020

### Team

- [Vincent Van Dessel](#) - CEO
- [Liina Edun](#) - Head of Content
- [Beatriz Azevedo](#) - Head of Digital.



## WE TAKE GAMES CEREASLY

### Big Idea

Cereal Games was founded in 2014 and is a company that is dedicated to mainly to the development of serious and educational games, from São Miguel Island in the Azores. Headquartered in the Science and Technology Park of São Miguel - Nonagon, in city of Lagoa, the company has developed several games, using technologies such as Augmented Reality, mobile devices and Internet of Things (IoT) to respond to requests from municipalities, schools, museums and scientific observation centers of the Region. Despite the significant focus on serious gaming, Cereal Games is currently working on an indie video game, which will soon part will be launched on an international scale.



### Sector

Games

### Team

[Lázaro Raposo](#) - CEO & Game Designer

[João Crispim](#) - Business Developer



## FAST AND EFFICIENT CONTENT DELIVERY IS THE KEY IN A DIGITALLY CONNECTED WORLD. CODAVEL IS THE KEY.

### Big Idea

At Codavel, they believe in content delivery at maximum speed and efficiency – for any user, device, network or content. They want their customers to provide their mobile app users with the best experience they can, and that's only possible by tackling what's currently out of control: the network. The inherent instability of the wireless last mile, such as Wi-Fi, 3G, 4G or even the upcoming 5G, is killing the speed of mobile apps. That's why Codavel has created Bolina. Its SDK controls network instability end-to-end, ensuring significant speed improvements in all kinds of network connections – and considerably improving the end-user's experience.

# codavel



### Sector

Networks

### Team

[Rui Costa](#) – CEO & Co-Founder

[Diogo Ferreira](#) – CTO & Co-Founder

[Paulo Oliveira](#) – Head of Security & Co-Founder

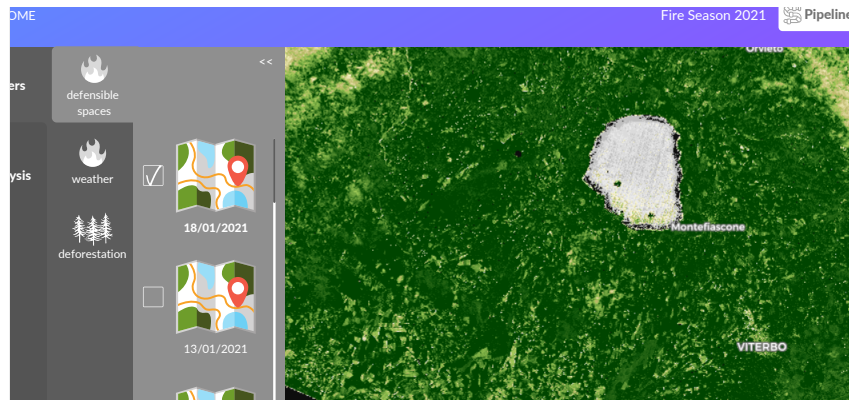

## CONNECTING STUDENTS TO KNOWLEDGE

### Big Idea

We believe that businesses should make a commitment to future generations and fight a global issue. Ours is climate change, starting with wildfires. We do this from space. We build a DIY all-in-one platform to cover the whole cycle of satellite image analysis.



**Sector**  
Digital

### Activity Highlights

2nd Prize - WaiACCELERATE 2020

### Team

[Ekaterina Stambolieva](#) - CEO



## CONNECTING STUDENTS TO KNOWLEDGE

### Big Idea

Critical Links started out as a division of global technology leader Critical Software in 2006 with a vision to provide powerful yet easy-to-use integrated technology platforms. This mission began with the award-winning edgeBOX unified communications platform and continues today in its flagship offering, the C3 Micro-Cloud solution for education.



**Sector**  
Enterprise

### Team

[João Carreira](#) - CEO & Founder





## A SMART APPROACH TO AI, DESIGNED BY DATA SCIENTISTS FOR DATA SCIENTISTS

### Big Idea

DefinedCrowd offers an intelligent data infrastructure for AI that provides high-quality training data to help machine learning-based products reach market quicker and with better quality. It offers efficient data workflows that enable data scientists to collect, synthesize, enrich and structure training data by combining human intelligence and machine learning capabilities to accelerate enterprise AI initiatives.



**Sector**  
AI & ML

### Activity Highlights

- 2016 - Seed Investment \$1.1M
- 2017 - Launch of the Enterprise product Alpha Software-as-a-Service
- 2018- Launch of the data platform for the market and Series A of \$11.8M and Partnerships with IBM, Mastercard, Amazon and Microsoft
- 2020 - Series B investment \$50M

### Team

- [Daniela Braga](#) – Founder & CEO
- [João Freitas](#) – CTO
- [Walter Benadof](#) - COO
- [Daan Baldewijns](#) – Director of Customer Success
- [Sara Oliveira](#) – Director of Product
- [Beth Malloy](#) – VP of Finance
- [Mark Bomber](#) – VP of Marketing
- [Diogo Ferreira](#) – CTO & Co-Founder
- [Paulo Oliveira](#) – Head of Security & Co-Founder



**Sector**  
VR / AR

### Team

[Veronica Orvalho](#) - Founder & CEO

## HUMANIZING TECHNOLOGY

### Big Idea

Didimo is a spin-off from the University and it develops a technology that allows you to create hi-fidelity digital humans in just 30 seconds from a photograph or scan using your smartphone. This technology adds realism to virtual interactions with the aim of humanizing digital interactions. Bynd Venture Capital co-invested in the operation.





## CONTROL TOWER FOR ONLINE SALES

### Big Idea

A single product checkout can beat a 21% conversion rate. Digital Manager Guru has built the most powerful platform to help your online sales be more profitable.



### Sector

Media and Information Services

### Team

[André Cruz](#) – CEO  
[Michelle Oliveira](#) – COO  
[Juliana Martinelli](#) – Marketing  
[Rute Salvado](#) – Marketing  
Pedro Jogo – Digital Media  
[Josué Duarte](#) – Digital Media  
[Paulo Carvalho](#) – Developer  
[Daniel Mota](#) – Developer  
[Tiago Leal](#) – Support  
[Miguel Stuart](#) – Support  
[Tiago Alhada](#) – Support



### Sector

Enterprise

### Activity Highlights

2018 - Best of INFOCOMM “Best Overall Digital Signage Product”  
2015 - Outstanding Venture of the Year Award Portugal Ventures  
2014 - Digital Signage Awards Winner  
2009 - Viscom “Best Practice in Digital Signage”

### Team

[Miguel Fonseca](#) – CEO  
[Miguel Oliveira](#) – Co-Founder

## ULTRA LARGE PROJECTED CAPACITIVE MANUFACTURER

### Big Idea

Displax is a projected capacitive multitouch technology manufacturer. Displax was the first company in the world to develop a large format multitouch film, which was successfully introduced to the market in September 2011. Since then, Displax has introduced several innovations to the market and achieved important milestones in the projected capacitive multitouch field. Displax has headquarters in Europe, Portugal, and also has a direct presence in the U.S. and in Taiwan.

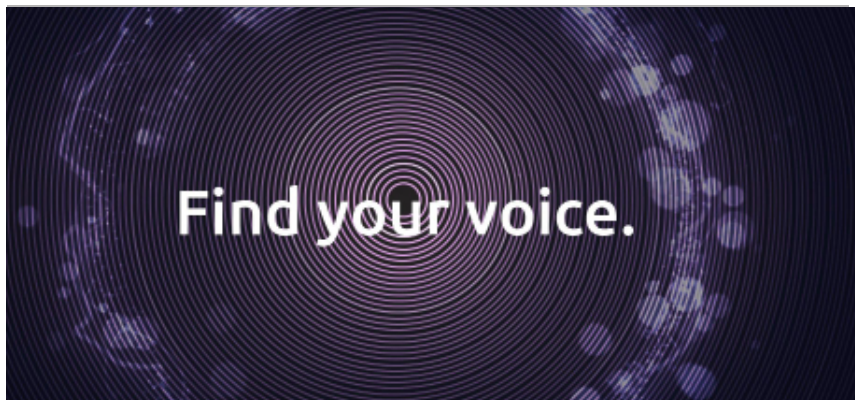

## FIND YOUR VOICE

### Big Idea

Based in Portugal, Doppio makes conversational games about people and their relationships, discussing life's biggest questions in a delightfully surprising and humorous way. The company is led by a group of voracious readers and knowledgeable gamers who are passionate about using voice to bring storytelling and game design closer together. To achieve this, Doppio brings its experience from renowned studios such as BioWare, Playfish and Digital Chocolate, together to demonstrate that voice is the new touch for the gaming industry.



**Sector**  
Games

### Team

[Jeferson Valadares](#) - CEO & Co-Founder

[Christopher Barnes](#) - CTO & Co-Founder

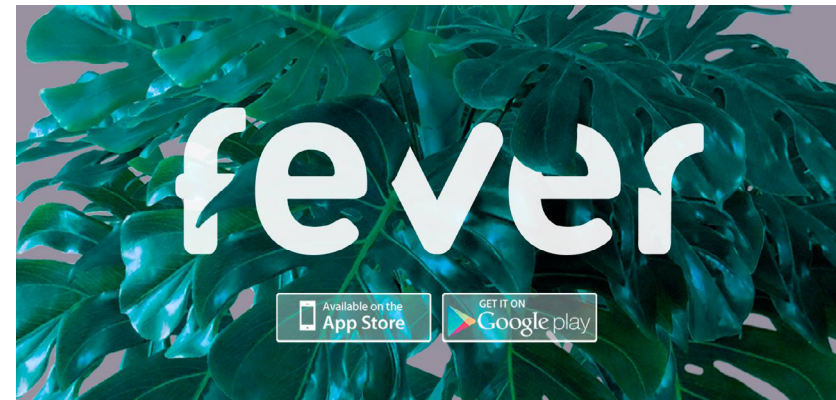

## DISCOVER THE BEST EVENTS IN YOUR CITY

### Big Idea

Fever is an events and experiences technology startup focused on inspiring users and helping event organisers generate greater demand. The Fever mobile app and website reach and inspire over 12 million unique users per week in its key markets (London, New York, Paris and Madrid), allowing them to discover the best events in their city. With its recommendation algorithm, the app features personalised listings for each user, for everything from music festivals and theatre to fashion, restaurants and a host of other events. Based on its users' preferences and behavioral data analysis, Fever is able to reveal and predict untapped demand for events that aren't even available yet. The company has begun using data to create its own events – Fever ORIGINALS, driven by the interest of Fever users. Fever will also use funding to build up its Fever ORIGINALS offering in the cities in which it operates, including Lisbon.



**Sector**  
Marketplaces

### Team

[Ignacio Bachiller Ströhlein](#) - CEO

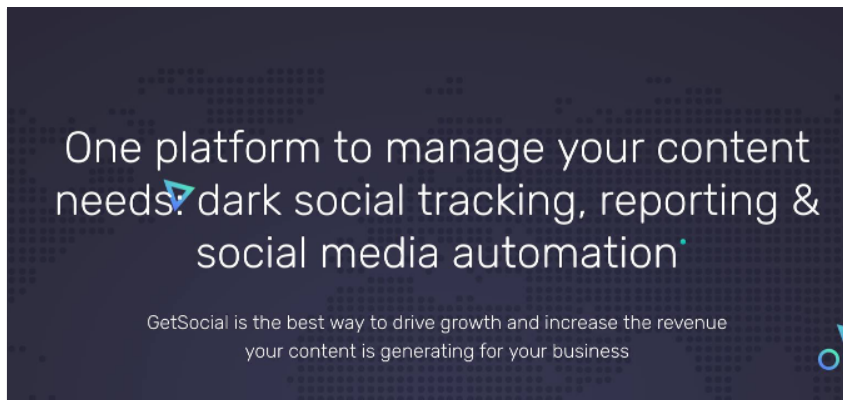

## THE DARK SOCIAL & AUTOMOTIVE DISTRIBUTION OF YOUR MOST VIRAL CONTENT

### Big Idea

A content analytics platform that helps publishers and brands understand how audiences are engaging with their content.

## GETSOCIAL



**Sector**  
SaaS

**Team**  
[João Romão](#) - CEO & Founder



## LEADING CLIENT-SIDE SECURITY SOLUTION FOR JAVASCRIPT SOLUTION

### Big Idea

Jscrambler is the leader in client-side security. The company's enterprise-grade security solutions enable JavaScript applications to become self-defensive and resilient to tampering and reverse-engineering, while also providing complete visibility over client-side attacks, including DOM tampering, web supply chain attacks and customer hijacking. Jscrambler is trusted by the Fortune 500 and 43,000+ companies and individuals globally.



**Sector**  
Cybersecurity

### Activity Highlights

Recognised in Gartner's market guides for In-App Protection and Online Fraud Detection

**Team**  
[Rui Ribeiro](#) - CEO  
[Pedro Fortuna](#) - CTO

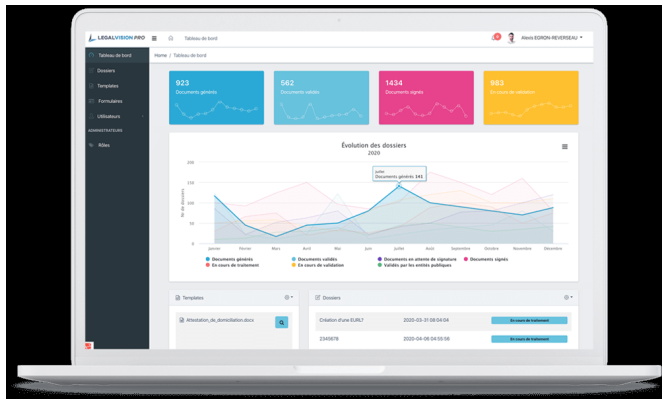

## LEGAL PROCESSES ALL-IN-ONE

### Big Idea

Legalvision develops an ALL-IN-ONE solution to accelerate the management of corporate legal processes. Legalvision's contract management solution allows corporate legal professionals to create, manage, review, sign and validate corporate legal documents.



**Sector**  
Legal Tech

### Activity Highlights

Award 2019 - 2nd Best French LegalTech  
Trophées du droit 2019 - Edition Enterprise

### Team

[Loïc LE GOAS](#) – CEO & Co-Founder  
[Miguel Figueiredo](#) – CTO & Co-Founder  
[Gonçalo Alves](#) – CFO & Co-Founder

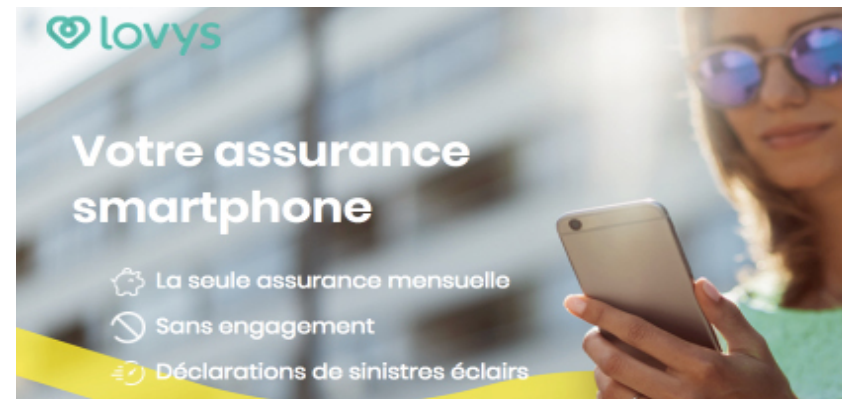

## ALL-IN-ONE INSURANCE

### Big Idea

Lovys aims to revolutionise the insurance market. Based in Leiria, it set its sights on France as its first market, where it identified an opportunity in the consumers' lack of confidence in insurance companies and the sector's lack of digitization in the country. Lovys offers a 100% digital solution and can aggregate multiple insurance subscription policies into a single monthly payment, making household management easier.



**Sector**  
Insurtech

### Team

[João Cardoso](#) - CEO & Founder  
[João Janes](#) - Head of Marketing  
[Elise Moutarlier](#) - VP of Operations & Founder



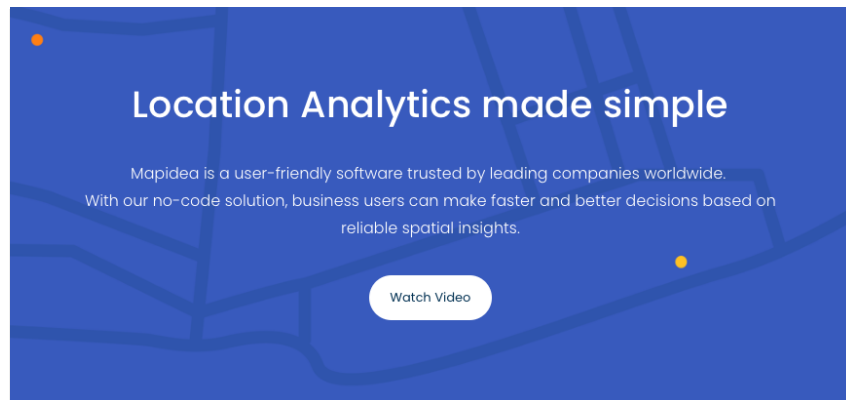

## LOCATION ANALYTICS SOFTWARE FOR BETTER BUSINESS DECISIONS

### Big Idea

Mapidea is a web-based Enterprise Location Intelligence SaaS deployed on the Cloud or On-Premises. Designed under the core principles of simplicity and speed, it supports a large number of business users from distinct areas in a collaborative analytical environment. It's a ready-to-use, zero-setup solution that combines internal and external data sources using geography as a common dimension. Companies from several industries like Vodafone, Domino's Pizza, Novartis and others are using Mapidea to improve their businesses. What about you?

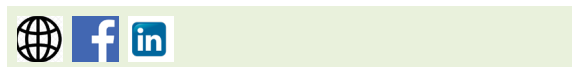

### Sector

SaaS

### Team

[Miguel Marques](#) – CEO & Founder

[Eduardo Ramos](#) – CTO & Co-Founder

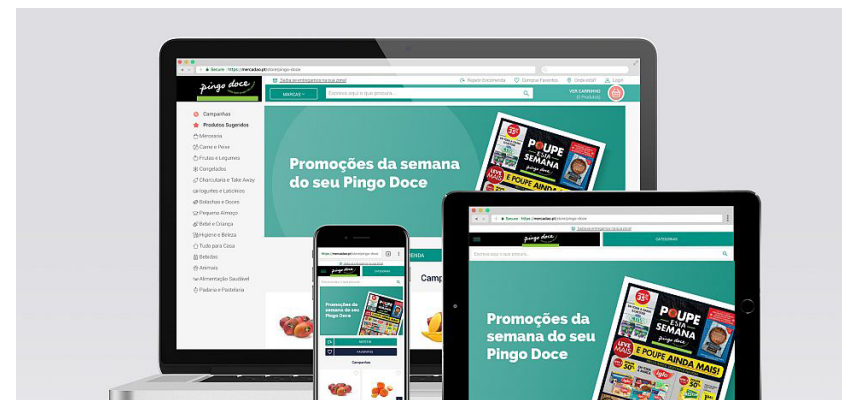

## EVERYTHING.ONLINE.INSTANTLY

### Big Idea

Mercadão is the first on-demand marketplace in Portugal, with deliveries made in 2-hour slots and real-time tracking of orders. Partner stores include leading retailers such as Pingo Doce and The Body Shop, and same-day deliveries are available in the Lisbon and Porto metropolitan areas. The app is now also available to multiple Portuguese district capitals. Speedy delivery is possible thanks to the platform's exclusive technology and an innovative logistics model, backed by a large team of personal shoppers.

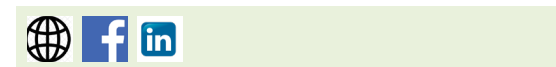

### Sector

SaaS

### Team

[Gonçalo Soares da Costa](#) - CEO



## IS YOUR MEDIA CONTENT ENGAGING ENOUGH?

### Big Idea

MindProber is the world's first automated biometric media testing platform. We offer media owners and broadcasters data on the second-by-second emotional impact of television and other video content, by recording the biometric reactions of thousands of viewers as they watch content from their homes. Our clients use these engagement metrics to optimize media products, and valueate and show efficacy of their media inventories.



### Sector

Media and Information Services

### Activity Highlights

Winners of the IIEX Innovation Award North America (UK)  
Winners of the MRS ASC Breakthrough Technology Innovation (UK)  
Shortlisted Prémios NOS Inovação  
Shortlisted the MediaWeek award (along with the ITV - UK)

### Team

[Pedro Almeida](#) - CEO  
[Nuno Dias](#) - CTO  
[Joe Timson](#) - CRO

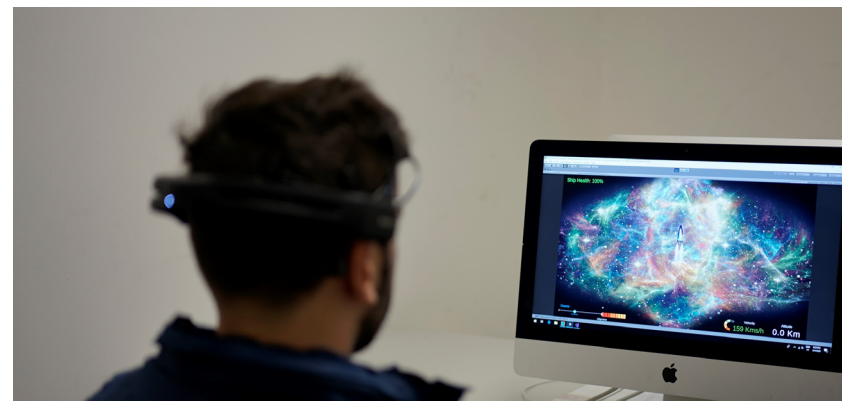

## EXPLORE HUMAN POTENTIAL

### Big Idea

Neroes improves athletes' performance and mental wellbeing through advanced brain technologies.



### Sector

Digital

### Activity Highlights

Best Scientific innovation Award in the International Conference, Physioma.  
WebSummit - highlighted as one of the most promising startup in the world.

### Team

[Pedro Pestana](#) - CEO  
[Valter Costa](#) - CTO.



## TRANQUILITY. WELL-BEING. SAFETY

### Big Idea

OneCare solutions aims to be European solution most chosen to support elderly people with some kind of dependency by delivering quality services for health and wellness promotion of them and their caregivers. Smart Monitoring mission is to use of ICT technologies to address a better care to the ones who had took care of us by allowing our relatives to live with comfort, autonomy, safety and perceived being close their beloved ones. OneCare is an innovative system for monitoring elderly daily life activities and provide neurocognitive stimulation games. It is focused at filling a gap on existing Ambient Assisted Living solutions by promoting social interaction and mobility of its end-users using gamification and artificial intelligence. It is a powerful tool for caregivers track insights about care status and progress on health indicators, helping them to delay seniors' institutionalization.

# ONECARE



**Sector**  
Digital

### Activity Highlights

Prize for Good Active and Healthy Aging Practices, in the Knowledge + area, CCSCRC

### Team

[Marta Pinto](#) - CEO



## REAL-TIME LOCATION-BASED MOBILE MARKETING

### Big Idea

Passworks allows brands to engage with consumers in real-time based on their location through native mobile wallet apps, such as Apple Wallet or Google Pay. By using the Passworks platform, brands can create, manage and distribute digital content directly to the customer's mobile wallet. It focuses particularly on the retail industry, with mobile coupons and store/loyalty cards, and on the ticketing industry, with mobile event tickets.



**Sector**  
SaaS

### Team

[Francisco Belo](#) - CEO & Co-Founder  
[Luis Mendes](#) - CTO

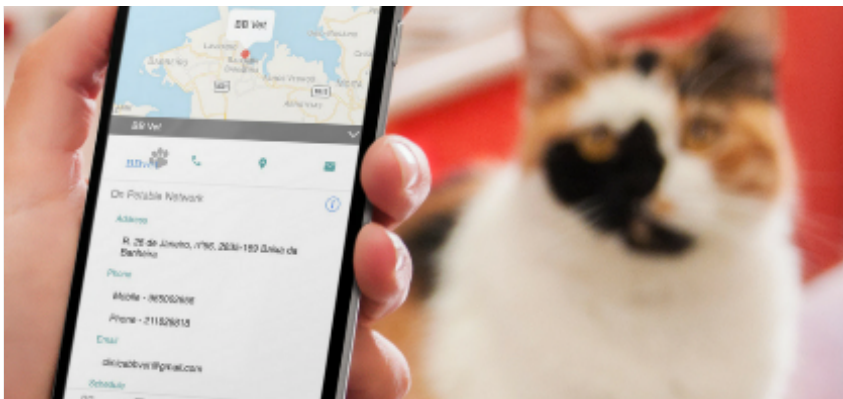

## CHANGING FAMILIES LIVES, ONE PET AT A TIME

### Big Idea

Petable is a middleware and information repository that facilitates communication between veterinarians and animal owners.



**Sector**  
Mobile

**Team**  
[Bruno Farinha](#) - CEO



**Sector**  
Cybersecurity

**Team**  
[Nuno Loureiro](#) - CEO & Co-Founder  
[Tiago Mendo](#) - CTO & Co-Founder

## WEB APPLICATION VULNERABILITY SCANNER

### Big Idea

Probely finds vulnerabilities or security issues in web applications and provides guidance on how to fix those issues. It can be integrated into development processes (SDLC) and continuous integration pipelines (CI/CD), in order to automate security testing. Probely helps you narrow the gap between development, security and operations, by making security an intrinsic characteristic of the web development life-cycle and achieve fast time-to-market.





## WORKING TOGETHER TO DO MORE WITH LESS

### Big Idea

Processware is a Global Technology Group that provides consulting services and break through technology. Processware delivers best-of-breed solutions to plan, optimise and control the handling of traceable goods throughout the supply chain using its flagship platform, O2P. O2P Solutions delivers a state-of-the-art technology platform to customise enterprise grade solutions for physical operations, working in harmony with existing ERP frameworks and without the need for custom development.

## PROCESSWARE



**Sector**  
Enterprise

**Team**  
[Filipe Janela](#) - CEO  
[Luis Santos](#) - CTO

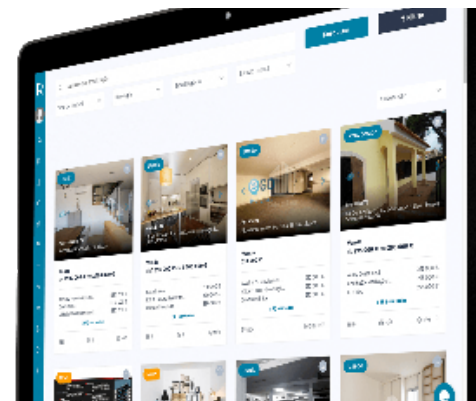

## REATIA



**Sector**  
Real Estate Technology

**Team**  
[Hugo Venâncio](#) - CEO

## THE ESSENCIAL TOOL FOR REAL ESTATE OR CONSULTANT SUCCESS

### Big Idea

REATIA is a real estate metasearch platform that uses Artificial Intelligence to aggregate properties in one place. REATIA has the largest and most transparent base of properties in Portugal. Our users can monitor the real estate market and properties in real time. With our technology we deliver a unique listing, Property Valuation and Market Analytics.



## WE LOVE PLAYING GAMES, AND MAKING THEM

### Big Idea

Our vision is to create innovative and differentiated games for PC and consoles with high quality and focus on the needs of the gamer community as well as their socialization.



**Sector**  
Gaming

### Activity Highlights

1st place Startup Contest Praia Links 2018  
Azores Regional Entrepreneurship Contest  
Finalist 2018  
StartUp ALPHA Web Summit 2018  
StartUp ALPHA Web Summit 2019  
TOP 50 Most Mediatic Portuguese Startups by  
Cision (47th) 2018  
TOP 50 Most Mediatic Portuguese Startups by  
Cision (22th) 2019  
Nomination Startup of the Year for Portugal for  
South Europe Startup Awards 2020  
Nomination Founder of the Year for Portugal for  
South Europe Startup Awards 2020

### Team

[Marco Bettencourt](#) – CEO



## THE LEADING PORTUGUESE COMPANY IN AREA OF EDUCATIONAL AND SCIENTIFIC TOYS

### Big Idea

Science4you is a 100% Portuguese company dedicated to the development, production and commercialisation of educational and scientific toys to stimulate children's knowledge acquisition. It currently has offices in Lisbon and Porto, and subsidiaries in Madrid and London. It regularly exports to over 60 countries and has a range featuring over 500 scientific and educational toys. It also offers other services, including science birthday parties and summer camps, science workshops at schools and after-school clubs, and training for young people and teachers.



**Sector**  
E-commerce

### Activity Highlights

2016 - Portugal Product of the Year  
2015 - France Chamber of Commerce Innovation Award  
2014 - European Business Awards National Champion;  
Portugal Ventures startup of the year  
2013 - UK Business Internationalisation Award; Brand  
awards (Time out Brand of the Year  
Product Awards (Prémio del Público - Ibertoy 2015, Toy  
Shop UK Independent Toy Awards 2015 and G! come  
Giocare Milano Toy Award 2015)

### Team

[Miguel Pina Martins](#) – CEO  
[Tiago Alves](#) – Marketing & Sales B2C  
[Tiago Pegado](#) – COO  
[Filipe Silveira](#) – Head of Innovation  
[João Simões](#) – CFO  
[Manuel Laia](#) – Head of Sales



## DIGITAL DELIVERY MANAGEMENT FOR ECOMMERCE

### Big Idea

Shiptimize is a Digital Delivery Management Solution that automates the shipping process of online stores so that shop owners and their teams can have more time to grow their business. Easy to integrate with major eCommerce platforms, using apps and plugins, the software centralises all shipping information on a single online platform, in addition to offering shipping options with multiple carriers. The solution also automates the label printing process, sends tracking e-mails and provides customer care, contacting carriers on behalf of the store when needed, keeping shop owners updated on the process.



### Sector

E-commerce

### Team

[Mark Bastiaanssen](#) – Founder & CEO

[Jorn Spiertz](#) – Co-Founder



## MAKE YOUR BUSINESS SMARTER AND GREENER

### Big Idea

TesselO helps organizations become more sustainable by using open Earth Observation data and AI. TesselO's solutions allow to better manage natural resources and continuously monitor climatic risks at any scale, anywhere on the planet. TesselO leverages open satellite imagery, enhanced with machine learning and environmental science, to unravel information about tree health, vegetation growth, soil composition and natural disaster risk & assessment. The users are infrastructure managers willing to control vegetation around their assets, timber producers, insurance companies, public bodies and NGOs. TesselO has been awarded 4 grants from the European Space Agency and the European Commission since its inception.

# TESSELO



### Sector

Digital

### Activity Highlights

3 European Space Agency grants: 2017, Business Incubation Center; 2018, Kick-start; 2019, Copernicus Incubation Program  
European Commission grant: SME Instrument, 2019

Finalist of Beta-i international Program Pro-Teching, 2019

Finalist of Beta-i international program Free Electrons, 2020

Top 6 Iberian Impact Finalists / Prémio Empreendedor XXI granted by Caixa Bank & BPI, 2020.

### Team

[Rémi Charpentier](#) – Co-founder & CEO

[Daniel Wiesmann](#) – Co-founder & CTO

[Michael Flaxman](#) – Co-founder and Chief Science Officer

[Marine Utgé-Royo](#) – Co-founder & Chief Sustainability Officer.



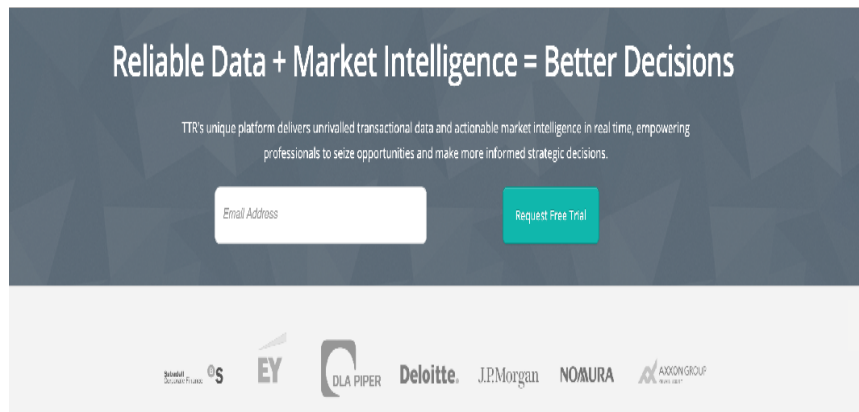

## RELIABLE DATA+MARKET INTELLIGENCE

### Big Idea

Transactional Track Record (TTR) is a premium financial technology platform that delivers unrivalled transactional data and market intelligence in real time, empowering professionals to seize opportunities and take more informed strategic decisions. TTR aggregates transactional data from thousands of sources, providing an indispensable resource to track announced, completed and cancelled transactions covering all sectors. TTR's research department uses proprietary technology to aggregate information from thousands of international sources, including newspapers, regulatory records and stock exchange announcements. TTR cuts out the noise for subscribers and provides current transactional data and market intelligence via customised e-mail alerts and a personalised online dashboard. TTR offers unparalleled market visibility for companies, investors and consultants.



**Sector**  
SaaS

**Activity Highlights**  
2013 - CODiE Awards Winner - Best Financial Platform

**Team**  
[Pedro Trinité](#) - CEO & Co-Founder



## ONLINE OUTLET OF MULTI-BRANDED LOCAL BOUTIQUES

### Big Idea

United Boutiques is an online tech-platform that sells deadstock from fashion multi-branded local boutiques, allowing items that have already been produced to be sold in a new sales channel with global reach and visibility, thus increasing the chances of being bought. Through a digital marketplace with state of the art e-commerce dedicated technology, customers navigate through the stock of fashion items and get recommendations accordingly with their preferences and habits.

unitedboutiques



**Sector**  
Digital

### Activity Highlights

Startup Voucher  
CETEIS  
Rise For Impact  
Fundo Ambiental

### Team

[Catarina Nogueira](#) - CEO & Founder  
[Dário Fonseca](#)  
[João Fonseca Bigotte](#)  
[António Seica](#)

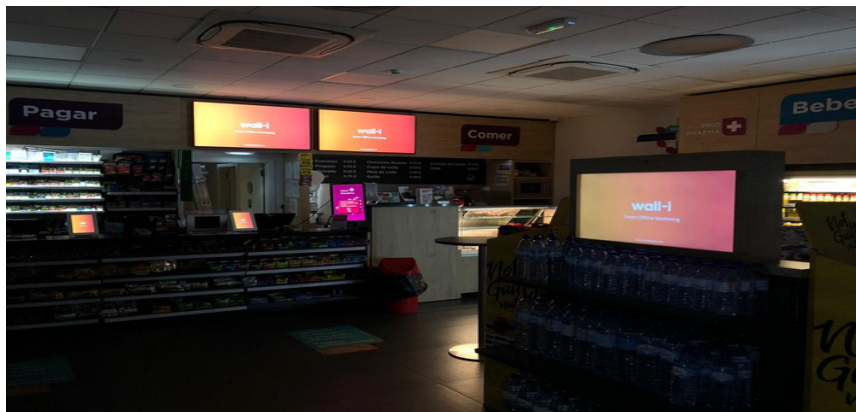

## BUILDING SMART DISPLAY NETWORKS

### Big Idea

Wall-i is a programmatic outdoor advertising network, that displays ads in screens for segmented audiences, by age, gender, location and market, in places such as retail stores, supermarkets, hotels, insurance and banking branches and agents, stimulating the immediate purchase of a specific product or service by that specific audience. Wall-i aims to be the Google Ads of the outdoor advertising. By combining plug-and-play screen incorporation and audience recognition technology (age, gender and mood), with a CPV /CPM business model, it enables real-estate owners to monetize LCD screens and tablets with ads.

# wall-i



**Sector**  
Digital

### Activity Highlights

Fidelidade Protechtng Startup Accelerator Winner  
Prio JumpStart Winner  
Altice IoT Challenge Winner  
Beta-i LisbonChallenge Winner

### Team

[José Lima](#) - Co-founder & CEO  
[Sérgio Piçarra](#) - Co-founder & CTO  
[Pedro Figueiredo](#) - Co-founder & CFO



## SMARTER IN-STORE SHOPPING EXPERIENCE

### Big Idea

A mobile shopping and checkout solution aimed at providing a smarter personalized instore shopping journey for shoppers and offering retailers a new way to personalize and improve their customers' shopping experience. It provides shoppers with a smart in-store shopping experience through a convenient and personalized journey, with a fast checkout (Beep & Go). YouBeep offers retailers a mobile shopping & checkout solution, via a plug and play Connector, at a fraction of the cost and time compared to current solutions. Its patented plug & play shopping and checkout solution has been tested across markets and retailers, reducing checkout times and maximizing basket values.



**Sector**  
SaaS

### Team

[João Paulo Rodrigues](#) - CEO & Board Executive  
[João Claro](#) - CSMD  
[Rui Margarido](#) - R&D Director  
[John Eustace](#) - Board Member & Non-Executive Director



## PAYMENT AND CASH SOLUTIONS

### Big Idea

Zarph's Deposit and Payment Solutions wouldn't have the same value if they weren't integrated with a web platform that enables all processes to be automated. This platform offers added value through cash management process automation and by connecting all stakeholders: Company – Bank – CIT. This process gives you real-time information and is in compliance with every company's internal process.



### Sector

Financial Software & Electronic Equipment

### Team

António Oliveira - CEO

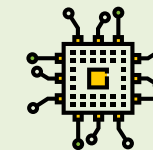

# Portfolio

Engineering & Manufacturing



47  
COMPANIES



31  
MILLION EUROS  
INVESTED

since 2012 - new investments and follow-ons

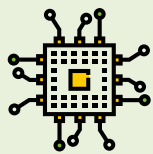

# Portfolio

Engineering & Manufacturing



**47**  
COMPANIES



**31**  
MILLION EUROS  
INVESTED

since 2012 - new investments and follow-ons

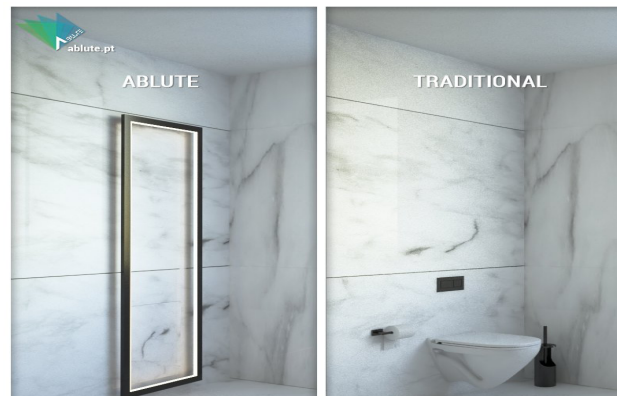

## THE TOILET PERFORMS URINALYSIS AND CONVEYS RESULTS IN SIMPLE WAY

### Big Idea

Ablute is a urinalysis device integrated in a toilet. The toilet is exclusive and wash itself, completely, with almost no water and no detergents, after each use. Medical analyzes are instantly transmitted to the user in a simple language and completely to the doctor. The mission aims to provide exams free of charge and the recognition that the information obtained in each analysis serves, in addition to its clinical importance, the interest of daily use for non-medical information. The company develops the sanitary hardware, as well as the medical device. It includes the software that transmits the analyzes to the user and doctor, as well as a revolutionary Lab-On-a-Chip, with resilient characteristics, designed for continuous reuse, without discards or consumables. Frequent monitoring is essential for early diagnosis, as well as disease surveillance and control. The exams carried out in the Ablute toilet do not cause trauma or pain to the patient and can be done with high frequency.



**Sector**  
E&M

### Team

[Nuno Marujo](#) - CEO  
[Carla Dias](#) - CTO  
[Bruno Nascimento](#) - CMO.





## PREMIUM AND COMPETITIVE FOODS

### Big Idea

About Acqua Food aims to produce and commercialize healthy, premium and competitive foods, under the maximum environmental responsibility. AAF recognizes natural resources as catalysts for investment in low-density territories, and seeks to achieve high quality standards and food safety, simultaneously promoting the sustainability of native resources.



**Sector**  
E&M

**Activity Highlights**  
1st Place – Smart Rural Contest 2018

**Team**  
[Fernando Espadilha](#)  
[Helena Freitas](#)  
[Nuno Simões Dias](#)  
[Ricardo Calado](#)



## ELECTRIFYING EVERY VAN TRUCK, TRAILER AND CONTAINER REFRIGERATION UNIT

### Big Idea

AddVolt presents the world's 1st Plug-in electrical system targeted for transportation markets. With our patented technology, transportation companies with refrigeration units can use electrical energy to reduce diesel dependence, the level of noise and the CO2 emissions during its operation. AddVolt creates high and positive impacts on the driver's quality of life, while it contributes to having eco-friendly vehicles.

ADDVOLT



**Sector**  
Electronics

**Activity Highlights**  
3rd place at the Trailer Innovation Award 2019  
Implementation of the Quality Management System, ISO9001:2015, through TÜV Rheinland CE certification  
E9 certification that allows vehicles with AddVolt systems to travel on all European roads

**Team**  
[Bruno Azevedo](#) – CEO  
[Miguel Sousa](#) – CTO  
[Ricardo Soares](#) – COO  
[Rodrigo Pires](#) – CCO





## ENDURING EXPERIENCE

### Big Idea

AJP is Portugal's premier manufacturer of Enduro motorcycles. Since 1987, the Company has been developing, manufacturing and selling motorcycles for recreational enduro, leisure and travel on the road. Its bikes are designed and built with simplicity and durability driving its intentions, and assembled with passion by a small, but very knowledgeable and enthusiastic team of engineers, using top-quality components. Essentially, they are trail bikes that can race, not race bikes to struggle with on the trail... Every single AJP motorcycle has been developed using cutting-edge technology, built under rigorous quality requirements, delivered with the utmost care and assisted by a body of qualified technicians to ensure the customer's satisfaction from the very moment of purchase all the way through to the riding of an AJP motorcycle.



### Sector

Motorcycle Manufacturer

### Team

[António Pinto](#) - CEO & Founder

[Miguel Oliveira](#) - Sales Manager



## WASTE LESS, LIVE BETTER

### Big Idea

Aqua More is an automation developed by Aroundinspire, Lda. located in Taguspark, in Oeiras - Portugal. This Water Saving Solution contributes to the water efficiency of buildings in both residential and professional areas and services, acting directly on waste in hot water taps and optimizing infrastructures for the distribution of hot water. Aqua More also aims to change the drinking water paradigm through information on consumption, savings and the Nexus Water/Energy. With this system, when opening a tap for the bath, the water will only come out when it is hot.



### Sector

E&M

### Activity Highlights

AQUA+ Award "Technologies of monitorization and water consumption: Tech AQUA+ Network, organized by ADENE, in collaboration with Planetiers, October 2020  
Start-Up Award in Portugal Smart Cities Summit 2019

### Team

[João Guerreiro](#) - CEO

[João Rosa](#) - CSO.



## ENABLE LOCATION EVERYWHERE

### Big Idea

Azitek has designed a low-cost indoor and outdoor geolocation solution for the automotive industry, airports and seaports. Based on proprietary RFID technology, the solution digitizes and locates high-value assets in large complexes and, through a platform, analyzes data and manages automated warnings, thereby optimising resource management. The company currently operates in the car distribution centre and dealership market, with a potential 100 thousand customers in Europe and America.



**Sector**  
Electronics

### Team

[José Valente](#) - CEO & Co-Founder  
[Rui Gomes](#) - Co-Founder



## EVENT MANAGEMENT SOLUTION WITH ID TECHNOLOGY

### Big Idea

Beamian offers a complete all-in-one events management solution comprising two major components: a cloud platform (that enables organisers to create and manage all tasks related to an event) and physical identifiers: smart badges (that identify visitors) and beamers (IoT devices that identify sites, brands and exhibitors) used during the event and which record all interactions between attendees, brands and exhibitors. The potential of the EMS (Event Management Software) market is valued at an estimated EUR 7 million and grows more than 11% per year.



beamian | digital you



**Sector**  
Electronics

### Team

[Sérgio Pinto](#) - CEO & Co-Founder  
[Sérgio Alves](#) - Co-Founder & Head of Product

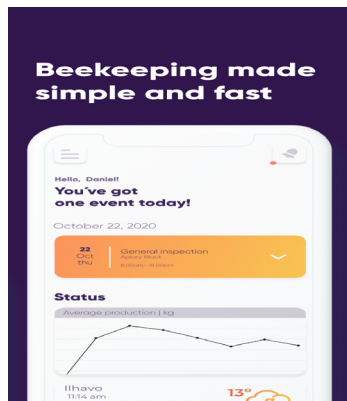

## BEEKEEPING SIMPLE AND FAST

### Big Idea

Beeyard provides to beekeepers a suite of tools for the management and remote monitoring of beehives with the aim of improving productivity in the honey production and pollination operations.



Beeyard



**Sector**  
E&M

**Activity Highlights**  
Seal of Excellence EIC 2020

**Team**  
[Miguel Bento](#) - CEO  
[Joel Oliveira](#) - Operations and Growth

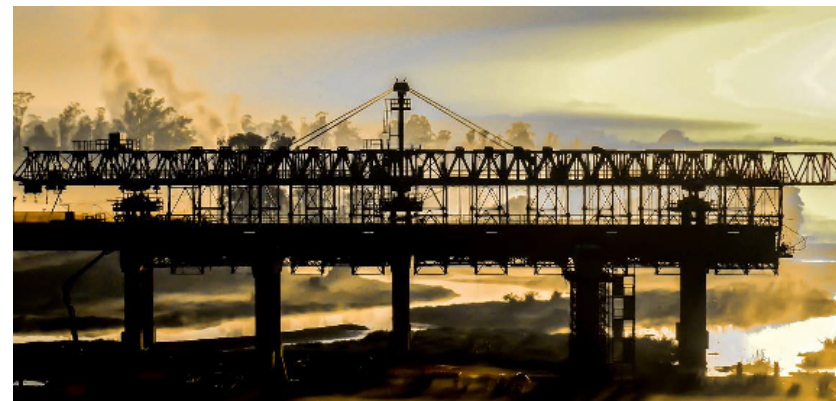

## ONE BRIDGE, ONE SOLUTION

### Big Idea

BERD investigates, develops and applies state-of-the-art solutions for bridge and viaduct construction methods. BERD's Movable Scaffolding Systems and Launching Gantries are equipped with OPS (Organic Prestressing System) and designed for the construction of bridges and viaducts with spans of up to 120 meters. Born in 2006, as a spin-off of the Faculty of Engineering of Porto University, BERD is one of the TOP 3 World Leaders in its field of expertise and was already involved in the construction of more than 20 bridges and viaducts in 5 continents. In 2016 BERD launched a new Business Unit: "Modular Bridge Solutions" that is currently supplying more than 150 modular bridges to Peru.

**BERD**®  
ONE BRIDGE, ONE SOLUTION



**Sector**  
Bridge Engineering

**Activity Highlights**  
2018 - Involved in 7 projects in 5 continents  
2017 - Involved in 6 projects in 4 continents  
2016 - Involved in 5 projects in 4 continents  
2015 - Involved in 5 projects

**Team**  
[Pedro Pacheco](#) - CEO  
[Diogo Graça Moura](#) - VP  
[Pedro Loureiro](#) - CFO  
[Brigitte Rouquet](#) - Marketing Director

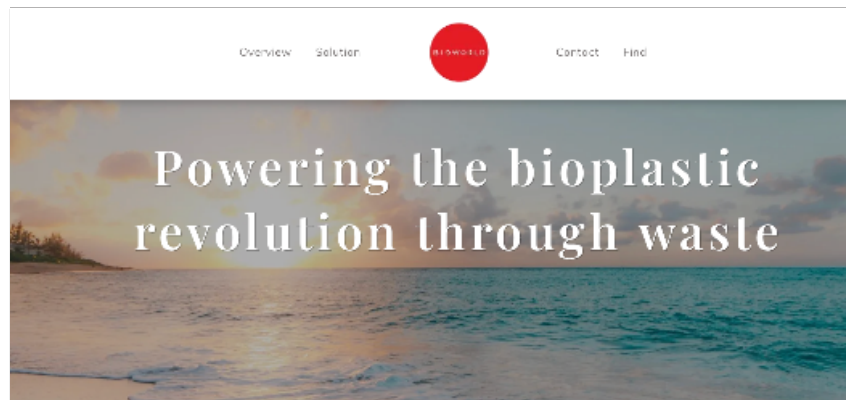

## POWERING THE BIOPLASTIC REVOLUTION THROUGH WASTE

### Big Idea

Bioworld – Social Impact, makes circular business models as part of the transition from a linear to a circular economy. It provides sustainable solutions using wastewaters from the agrifood industry, with a positive impact on economic, environmental and social. Redesigns packaging solutions through circular business models, preserving quality and boosting end-of-life product.



**Sector**  
E&M

### Activity Highlights

First Place of the Blueact  
Super Bock Group Award to companies dedicated to sustentability and circular economy

### Team

[Suzana Alípio](#) – CEO  
[Francisco Pereira](#) – CFO  
[Honorata Pereira](#) – CTO  
[Vitor Teixeira](#) – CMO



## PROUDLY PRESENTING THE MOST AWARDED AND INTERNATIONAL BRAND OF PASTEL DE NATA

### Big Idea

Identification of traditional Portuguese pastry products, sweet and savory, with potential for differentiation to be presented and introduced in the various channels of foreign markets, respecting the products' origin, characteristics and distinctive aspects, with a strong innovation component. The company's main goal is to meet the needs of the global food market. The company's goal is to be among the main players in the global market, with clear leadership in the Portuguese market, a capable, ambitious and flexible decision-making structure and being a reference in the markets and industry in which it operates, as well as with stakeholders.



**Sector**  
Food Processing

### Team

2 stars at the 2015 Great Taste Awards  
1 star at the 2018 Superior Taste Awards.

### Team

[Mabilio de Albuquerque](#) – CEO & Founder  
[Pedro Manso Pereira](#) – Executive Board Member





## SOLAR WASH AND INDUSTRIAL GLASS PROTECT

### Big Idea

Chemitek offers innovative solutions for the maintenance and protection of different materials, namely solar panels and windows, keeping them clean for longer. Today, 70 thousand solar panels are installed an hour across the globe and this is the target-market, whose technology reduces accumulated dirt from the glass and thus increases the energy produced by solar panels. The windows market is another vertical, where cleaning costs are high and Chemitek's product helps cut costs and save on the required infrastructures.



**Sector**  
New Materials and CleanTech

**Team**  
[César Martins](#) - CEO & Founder



## CLEAN ENERGY. DECENTRALIZED, DIGITALIZED AND DEMOCRATIZED

### Big Idea

Their mission is to simplify, amplify and accelerate energy decarbonization for companies and communities around the world. They achieve this by focusing on two key vectors that drive value for our clients: smart energy efficiency and access to affordable clean energy. All our services are designed to reduce utility related operating expenses, complexity, volatility and unpredictability in respect of energy procurement, consumption, generation, storage, balancing and trading.



**Sector**  
E&M

**Team**  
[James McDougall](#) - Chairman & Co-Founder  
[Basilio Simões](#) - Vice-Chairman & Co-Founder  
[Michael Pinto](#) - CEO & Co-founder  
[Luisa Matos](#) - CTO & Co-Founder, MD Digital Services  
[José Queirós de Almeida](#) - CMO  
[Filipe Neves](#) - CFO  
[Sofia Pinto Barbosa](#) - MD Capital Services & Energy Policy  
[Gergely Bartok](#) - CLO

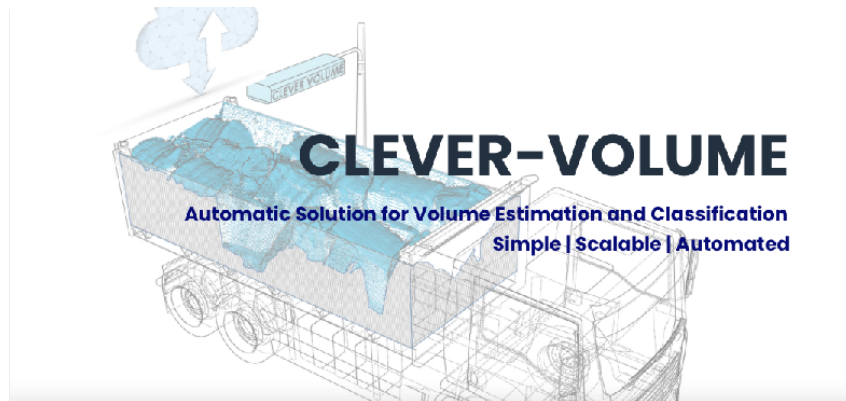

## AUTOMATIC SOLUTION FOR VOLUME ESTIMATION AND CLASSIFICATION

### Big Idea

CLEVER-Volume provides a simple, automatic, and scalable way to understand waste in seconds. With deep expertise in three-dimensional scanning, intelligent modeling, and spatial data analysis, we developed an innovative solution to measure and classify waste. Focused on Ports, we are capacitating Port Reception Facilities to manage boat-produced waste, remotely and in real-time, promoting economic savings, efficiency gains. We target ocean waste discharge reduction, accountable for about 30% of total ocean pollution, and to be an enabler of a true circular economy.



**Sector**  
E&M

### Activity Highlights

Winner of the "Smart Catalonia Challenge"  
Winner of the "Seal of Excellence" from European Union

### Team

[Jorge García Fernández](#) – Founder & CEO  
[António Sousa Patrício](#) – Co-Founder & COO  
[Leonor de Medeiros](#) – Partner



## PROTEIN ISOLATE USING WHEY THAT IS WASTED DURING CHEESE PRODUCTION AND FRUIT

### Big Idea

CORE Protein is developing a protein isolate using whey that is wasted during cheese production as using wasted fruit (also "ugly fruit") as flavour instead of a synthetic molecule. The product is, therefore, 100% natural, benefiting the entire supply and production chain, providing customers with good quality whey protein with the added benefit of consuming actual fruit and allowing the consumer to personalize their nutritional value intake. Lactose is a by-product of filtering protein out of whey and can be fermented into ethanol and sold as a disinfectant or to alcoholic beverages companies or even as a biofuel. We are currently identifying optimum drying and filtration conditions, comparing several innovating techniques to evaluate cost/benefit in hopes of identifying the most economically viable combination of techniques and finalizing and MVP.



**Sector**  
E&M

### Activity Highlights

First Place Startup Weekend Azores 2016  
Second Place Concurso Regional do Empreendedorismo 2017  
First Place NASA Space Apps Challenge

### Team

[Rui Cordeiro](#) – CEO & Founder



## BIOPRODUCTION OF EXOTIC LEATHER

### Big Idea

Corium Biotech is a R&D company dedicated to the bioproduction of exotic leather destined to answer the current leather market needs for performant materials that respects both the environment and the animal wellbeing. We envisioned to be a solid alternative for leather manufacturer companies showing strong commitment to the modernization of leather industry and the ecologic transition of this sector.



**Sector**  
E&M

### Activity Highlights

National Winner of the ClimateLaunchPad

### Team

[Maria João Gonçalves](#) – CEO & Co-Founder

[Margot Muller](#) – Co-Founder



ENEIDA.IO  
Deep grid assessment



**Sector**  
IoT

### Team

[Carlos Pina Teixeira](#) – CEO & Co-Founder

[John Comprido](#) – Marketing & Business  
Development & Co-Founder

[José Egreja](#) – CFO & Co-Founder

[José Oliveira](#) – VP Product

## THE OPTIMISATION OF ELECTRIC GRID ASSETS

### Big Idea

Eneida.io's collaborative IoT platform for optimisation of the low-voltage network allows electric utility companies to increase the penetration of electric vehicles, solar PV systems and other low carbon technologies in their network, while offering higher quality and more secure and affordable energy to their customers.



**Sector**  
Auto Parts

**Team**  
José Aleixo Santiago  
Paulo Ferreira  
Ana Patrícia Lopes

## WHEN TECHNOLOGY AND QUALITY MERGE

### Big Idea

EPEDAL is a Portuguese company, founded in 1981, that manufactures metal components and subsets for the automotive industry. It aims to meet all of its customers, shareholders and employees' needs by prioritising the sector's critical factors: delivery times, quality and price. The company supplies components and subsets for seats, exhausts, refrigeration systems, chassis and bodywork, and uses the latest stamping, wire forming, automated soldering and assembly line technologies on the market. Certification of its quality assurance and environmental management system by BVQI (ISO/TS16949, ISO 14001 and ISO 18001) and by Volkswagen (VDA) attest to EPEDAL's ability to operate in this highly demanding market.

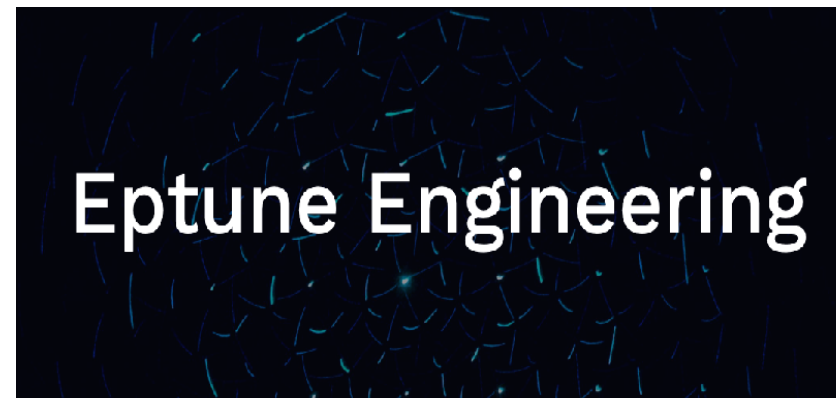

**Sector**  
E&M

**Team**  
[João Pedro Loureiro](#) - CEO

## SOLUTIONS FOR AEROSPACE AND EOLIC MARKETS

### Big Idea

Eptune Engineering is developing an innovative system that allows the wind turbine blade repair in harsh meteorological conditions, increasing the maintenance season duration as well as the turbine availability while reduce maintenance costs.





## SMART LIVESTOCK MANAGER

### Big Idea

Farmcontrol introduces IoT cloud software that integrates data from farm equipment and sensors with human inputs, which can be collected in real time, making it a value-added tool for agricultural producers. The cloud solution connects to a large number of devices with the possibility of processing automatic rules. By using reports and acting in a timely manner on the notifications received, the producer can evaluate and improve parameters such as environmental conditions, food, water consumption and energy costs, critical points to be economically more efficient and competitive in the global market, also ensuring compliance with environmental and animal welfare requirements. The software also guarantees in its production module an integral traceability solution for animal production lots.



### Sector

Business & Productivity Software

### Activity Highlights

The best pig farm in Portugal and 40% of the prize nominees in Portugal trust in farmcontrol (2017 - Porco d'Ouro prize in Portugal)

### Team

[António Correia](#) - CEO

[Rúben Madeira](#) - CTO



## TOGETHER WE CAN RE-SHAPE THE FUTURE

### Big Idea

Follow Inspiration is an innovative tech company. Its knowledge on hardware and software in the fields of robotics, image recognition and artificial intelligence allows it to develop leading-edge technologies for retail, industry and services. It believes that technology helps make things possible. Follow Inspiration's mission is to deliver innovation through new technologies in order to improve businesses and people's lives.

## Follow Inspiration



### Sector

Robotics

### Team

[Luis de Matos](#) - CEO



## ECO FRIENDLY TILES FROM WASTE TO WALL

### Big Idea

Based in Porto, Portugal, since 2018, with roots set in architectural practices, the team joins forces with material development labs and design schools, to implement the circular economy in design thinking, all the way from concept to the final product, adding value to waste management industry. Flowco is excited to announce GOMA XL, the first colorful and flexible sports floor made from the recycling of footwear. With the technical guarantee of impact absorption and thermal and acoustic improvement. With an annual consumption of 20 billion pairs of shoes, only 5% are recycled. By incorporating this waste in the production of GOMA, we contribute to increasing the value chain and implementing a circular economy. GOMA is an ecological product that favors the visual sense, as well as touch and smell. To break with the barriers of creativity, the gum adapts to curved surfaces, both concave and convex. With hand-selected waste by type and color, enhances a highly customizable service, placing the product on the high-end design market.



**Sector**  
E&M

### Activity Highlights

First Place in the competition of ideas Larus Design 15'  
Honorable Mention Innovation ValorPneu in the category Business and innovation at the exposition Bienal Ibero Americana in Madrid

### Team

[José de Almeida](#) – Co-Founder  
[João Sebastião Ataíde Goulão](#) – Co-Founder  
[Rodrigo Melo](#) – Co-Founder  
[António Vale](#) – Co-Founder

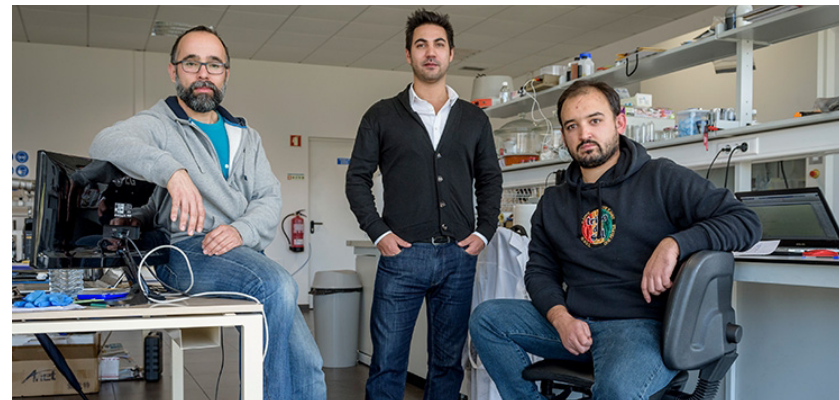

## TECHNOLOGY PROVIDER OF GRAPHENE-BASED SOLUTIONS

### Big Idea

Graphenest has developed a technology for the large-scale production of graphene and its functional derivatives, and operates in the nanomaterials sector. This technology is based on a new approach to the current state-of-the-art, giving Graphenest a huge competitive advantage in the international market as it is able to market the material at the fraction of the current cost. Focused on innovation, in the energy and electronics market, Graphenest will seek partnerships for research and development of emerging graphene-based applications.



**Sector**  
New Materials

### Team

[Vitor Abrantes](#) – CEO  
[Bruno Figueiredo](#) – Co-Founder  
[Rui Silva](#) – CTO



## SHAPING HEALTHIER FUTURES

### Big Idea

IHCare - Innovation Hospital Care is a startup company driven by three main principles: Investigation, Development, and Implementation of high-tech solutions, with emphasis on resource-saving to maximize healthcare units time and money. It's committed to delivering an effective response to all its stakeholders - patients, healthcare providers, and healthcare facilities administrations. IHCare's mission is to significantly improve patients comfort and well-being, offering effective means to fight healthcare problems, with global improvement on both clinical, human and financial levels.



**Sector**  
E&M

### Activity Highlights

Best Business Idea for Health Sector at Arrisca C  
2012 Business Competition, First Place  
Bolsa de empreendedorismo IAPMEI  
Innostars - EITHEALTH - 2018

### Team

[Diana Pires](#) - CEO  
[David Carvalhão](#) - CSO  
[David Cardoso](#) - CTO



## FLAT SHOES THAT MAKE A BETTER WORLD FOR WOMAN

### Big Idea

One day, a woman had a dream. Others joined her and Josefinas was created. Josefinas is a Portuguese brand inspired by a dream. In a country in crisis, where there was little room for dreams, making handmade shoes had a new name: Josefinas. In Portugal, there is something that has never died: the savoir faire of craftsmanship and the passion for an idea. "Never give up" has always been Josefinas' motto. The name Josefinas is in honour of the brand's co-founder Filipa Júlio's grandmother. The hope is that Josefinas' story will inspire the path of many other women, straight to making their dreams a reality, just as it inspires us every day!



**Sector**  
Marketplaces

### Team

[José Fernandes](#) - CEO



## SAVE MONEY AND HELP RENEWABLES

### Big Idea

Standby losses of electric water heaters are equivalent to the emissions of 2 mio cars, only in EU. Klugit smart plug made from recycled plastics converts your water heater into a smart device that prioritises renewable energy to heat up your water. Klugit's smart mode reduces up to -19% energy and water consumption, but more importantly uses water heaters to store clean energy, helping to solve one of renewables biggest problems – energy storage.



**Sector**  
E&M

### Activity Highlights

Bosch ACTT 2018  
Cleantech Camp by InnoEnergy 2018  
InnoEnergy Highway 2019  
Aveiro Urban Challenges 2020  
Road2Websummit 2020

### Team

[Tiago Bandeira](#) – Founder & CEO  
[Carla Antunes](#) – CSO



## DIGITAL PLATFORM FOR THE ENHANCEMENT OF ACORN

### Big Idea

Landratech is a physical and digital platform for the enhancement of acorn. Despite poorly explored, this highly nutritious and gluten-free fruit is extremely abundant in the native forests of northern hemisphere. The company now becomes a dynamic point that links the previously fragmented value chain. Landratech's innovation activities provide value-added solutions for both the acorn-producing forest owners, who struggle with the low yield of their woods, and for the food industry, which craves healthy and sustainable food with a positive impact on the environment. We are the driving force for a paradigm shift in the management of our native forests. With Landratech it is possible to have a strong economic return while keeping living and healthy forests.

# LANDRATECH



**Sector**  
E&M

### Activity Highlights

Finalists of the EIT Food Programme 2020 and Masschallenge  
Co-founders of the Confraria Ibérica da Bolota

### Team

Pedro Babo  
Raphaël Canadas





## TECHNOLOGY FOR SMARTER, MORE EFFECTIVE SAFETY

### Big Idea

Logical Safety is a Portuguese company with a vision to change how industrial safety and site management is carried out. With an experienced team of experts, the company builds with a mission to make work in the most dangerous places, safer and more productive. Using the most modern technologies, Logical Safety develops advanced industrial safety and maintenance solutions. The company offers a wide range of industrial solutions with focus on Industry 4.0, Artificial Intelligence and Augmented Reality systems for the Heavy Industry, Oil&Gas, Petrochemical and general Industries.



**Sector**  
SaaS

**Team**  
[Henrique Mateus](#) - CEO & Founder



## MAKE YOUR SOLAR PANEL INTELLIGENT

### Big Idea

Neuralsolar is a company with innovation DNA in the field of electronics, specialized in the development and design of monitoring and pattern detection patentable devices, in electricity production equipment using solar energy and monitoring solutions for large areas with reduced need for infrastructure, such as for example , monitoring pollution or illegal activities in the ocean or monitoring forest fires.

## NeuralSolar



**Sector**  
E&M

**Team**  
[António Figueira](#) - CEO  
[Mouhaydine Tlemcani](#)





## THE 4TH PLAYER IN THE PORTUGUESE COFFEE MARKET

### Big Idea

NewCoffee manages a portfolio of 6 brands – Lavazza, Bogani, Caffecel, Sanzala, Novo Dia and A Caféeira. It is currently focused on organic growth, a strategy that recently saw the rebranding of all its brands and enhancement of its management structure. Given the company's experience in the integration of acquired competitors, add-on acquisitions may also be considered, should there be opportunities with a strategic fit for NewCoffee.

## NEWCOFFEE<sup>®</sup>

COMPANY



**Sector**  
Others

**Team**  
[Pedro Oliveira](#) - CEO



## THE SMARTEST WAY TO GROW YOUR OWN FOOD

### Big Idea

Noocity wants to make Urban Farming accessible to everyone. The product the company has developed enables anyone living in an urban environment to grow and harvest their own vegetables in a practical, efficient and eco-friendly way. Designed and manufactured in Portugal, Noocity already has a strong international presence, with over 4,000 m2 of vegetable patches installed worldwide. In 2018, Noocity entered the French market and in less than a year nearly 50% of its growbeds sold were shipped to the country.



**Sector**  
CleanTech

**Team**  
[José Ruiivo](#) - CEO  
[Leonor Babo](#) - CMO & Co-Founder



## SMART IOT PLATFORM

### Big Idea

Omniflow develops and manufactures Omniled, an intelligent energy platform for the Internet of Things powered by proprietary solar and wind technology and includes batteries, used for various services such as street lighting, sensors, wi-fi and video surveillance.

**Omniflow®**



### Sector

Electronics and CleanTech

### Activity Highlights

2018 - EUR 2M round of investment with Hcapital  
2017 - Red Herring Top 100 Winner Europe  
2016 - Desafios Porto  
2015 - SME Instrument EU  
2013 - Altran Innovation  
2011 - ANJE  
2010 - EDP Richard Branson

### Team

[Pedro Ruão](#) – CEO & Founder  
Filipe Marçal – Industrial Director  
[João Sousa](#) – Finance Director



**POLYANSWER**



### Sector

New Materials

### Team

[Luis Vieira](#) - CEO

## THE FUTURE OF HIGH-IMPACT TECHNOLOGY

### Big Idea

Polyanswer is a tech-based company specialised in developing and producing non-Newtonian fluids, resulting in a flexible material with special impact energy absorption characteristics. With a strong research component, the company has established several partnerships with universities, technology development institutes and a number of companies in the past two years to incorporate their technology in the development of products for different sectors – footwear, textiles, sports, motorcycle, personal protective equipment and the military. In addition to products developed in-house, the company sells fluids as additives for several industries. Polyanswer is currently developing a material with dilatant properties for the automotive sector, in collaboration with BASF.



## PRODUCING MORE WITH LESS

### Big Idea

proGrow makes it possible for your organisation to continuously and sustainably improve its production processes. Its platform is built around the continuous improvement principles of DADA LOOP. proGrow is a flexible and dynamic platform which produces KPIs and reports, as well as monitors the impact of your actions, automatically, thereby promoting a culture of continuous improvement. You are collecting more than data, you are centralising the production know-how of your entire organisation.



**Sector**  
SaaS

### Team

[Marco Tschan Carvalho](#) – CEO & Founder  
[João de Sousa Aroso](#) – Non Executive Director



## ENERGY STORAGE SOLUTIONS

### Big Idea

The increased participation of renewable energy sources in the energy matrix, implies the development of innovative energy storage solutions to guarantee the integration of these intermittent energy sources in the energy distribution systems, it is for this reason, that energy storage is the key to the energy transition. Based on this scenario, they are developing an innovative solution, which will make it possible to take advantage of the available infrastructure at more than 33,000 vehicular natural gas filling stations in 90 countries, to store surplus renewable energy production, and to generate of electricity in a decentralized manner.



**Sector**  
E&M

### Activity Highlights

Honorable mention at the Smart Contest Hiese-2018  
Finalist of the Prio Jump Start -2018

### Team

[Ricardo de Mello Awazu](#) – CEO & Founder  
[António "Dourado" Ramos](#) – Engeneering & Development  
[Oswaldo Batista](#) – Development Engineer  
[Tomé Baptista](#) – Development Engineer





## DATA COLLECTION AND MONITORING SYSTEM FOR NATURAL AND INDUSTRIAL RESOURCES

### Big Idea

Data collection and monitoring system through artificial intelligence with a focus on the efficiency of natural and industrial resources.

## SCEMAI



**Sector**  
E&M

### Activity Highlights

Winner of the Prémio H2O Inovação Águas de Gaia from Acredita Portugal Award - 2020  
Finalist of the Pitch for Impact! Competition from Microsoft in the category Amorim and Microsoft - 2020  
Nominated to represent Portugal at the final of the European Startup Awards, by the European Commission - 2021

### Team

[Hugo Alexandre Trindade](#) - CEO  
[Rodolfo Carames](#) - Comercial & Sales  
[Filipe Gomes](#) - Instalation & Maintenance  
[João Loureiro](#) - Communication Systems & Networks  
[Paulo Silva](#) - Automation & AI  
[Sérgio Correia](#) - Technology Development

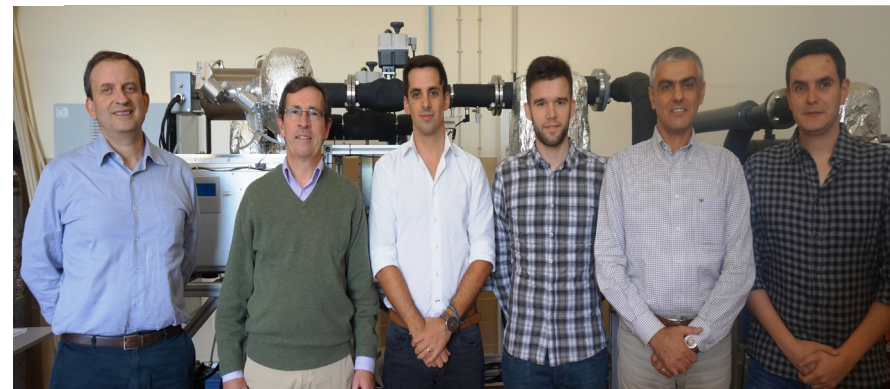

## SUSTAINABLE ENERGY GENERATION

### Big Idea

Development and exploration of energy generation systems based in biomass, with a proprietary cogeneration technology.

## sciven



**Sector**  
E&M

### Team

[Eduardo Machado Costa](#) - CEO  
[Jorge André](#)



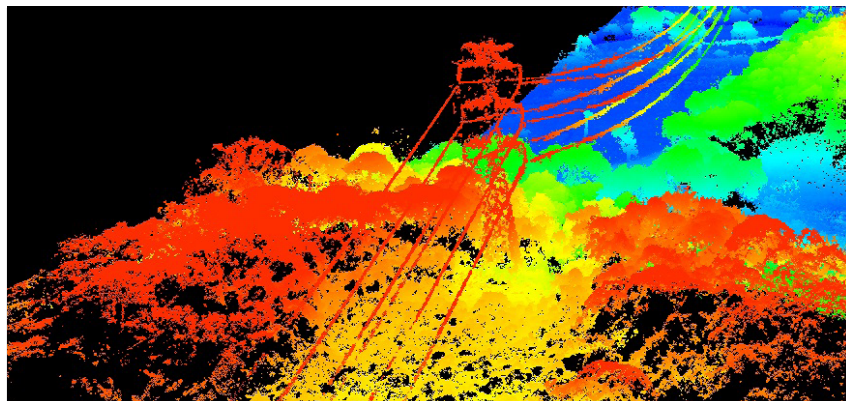

## INNOVATIVE & EFFICIENT AERIAL SOLUTIONS

### Big Idea

SkyPowerLines is a Portuguese startup that resulted from the softlanding process by the Brazilian Novarum Sky. It provides a scalable service of detailed inspection and 3D mapping of transmission and distribution lines through an innovative system for collecting and high-performance processing images and data, using a small and long-range drone with a 100% automated flight plan and flight, replacing with benefits the techniques of patrolling on the ground, the use of helicopters and large drones with LiDAR technology. Easy to use, integrated with IoT technologies, the Drone can be operated by the customer, partner Drone operator or by the SkyPowerLines pilot team.



**Sector**  
E&M

### Team

[João Marcelo Corrêa](#) – Founder & CEO

[Mario Azeredo](#) – COO

[João Marcos Castro Soares](#) – Founder & Advisor

[Juliano Grigulo](#) – Founder & Software Developer

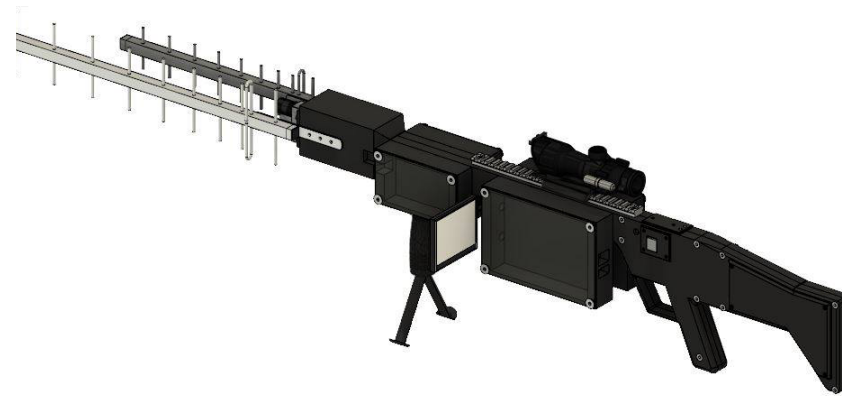

## ADVANCED TECHNIQUES OF SIGNAL EMISSION

### Big Idea

In recent times, there have been several reports of Unmanned Aerial Vehicles (UAVs) incidents involving aircraft in the airports or airfields. With the mobile system for immobilizing and diverting unauthorized UAVs, it is possible to protect the intrusion of unauthorized UAVs (commercial and custom-made), ground, air and water vehicles in restricted areas, e.g. airports, military areas, condominiums and occasional situations of public events or areas where it is necessary to ensure public safety. Since it is a mobile system, it can be easily and quickly adapted to the areas to be protected. This system minimizes interference with other systems and, on the other hand, implements advanced techniques of signal emission with high energy efficiency, minimizing the environmental footprint. The modular system was designed based on its ease of transport and handling by defense forces (military and public security).



**Sector**  
E&M

### Activity Highlights

Silver Medal (world's top 100) – China International College Students' "Internet +" Innovation & Entrepreneurship Competition

### Team

[Renato Ferreira](#) – Jamming & Beamforming Specialist and Network Developer

[João Gaspar](#) – Spoofing Specialist and Software Developer

[Pedro Sebastião](#) – Technical & Innovation and International Commerce

[Nuno Souto](#) – Specialist in transmission & analysis of radio telecommunications

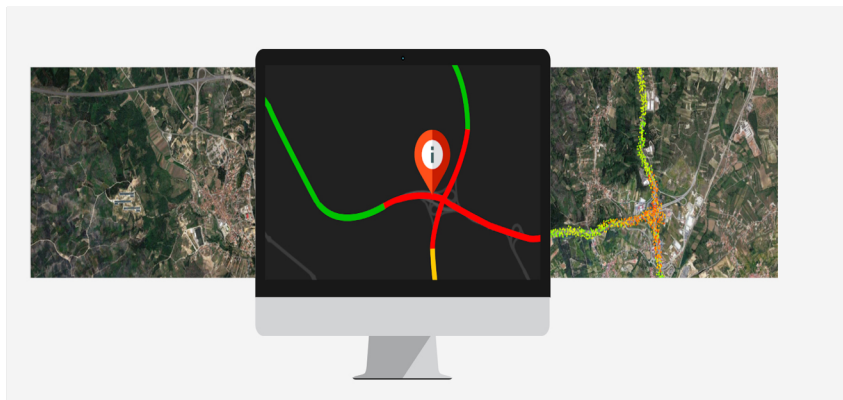

## INNOVATIVE SOLUTIONS USING REMOTE SENSING AND DIGITAL TECHNOLOGIES

### Big Idea

THEIA develops remote monitoring systems for infrastructure based on satellite data, designed to answer the needs of multiple industries. These monitoring systems aim for an early-detection of risk factors, minimizing the occurrence of critical situations and associated damages.

# THEIA



**Sector**  
E&M

### Activity Highlights

Project "SENSEOS": national winner of the World Summit Awards Portugal 2019 in the category "Culture and Tourism"

Project "ERMES - Extensive Road Monitoring Early-warning System": winner of the Copernicus Masters - BMVI Digital Transport Challenge 2019

Project "ERMES": Finalist Top 3 in the INNOspace DB Netz AG Challenge 2020

### Team

[Ricardo Cabral](#) - Co-Founder

[Martino Correia](#) - Co-Founder

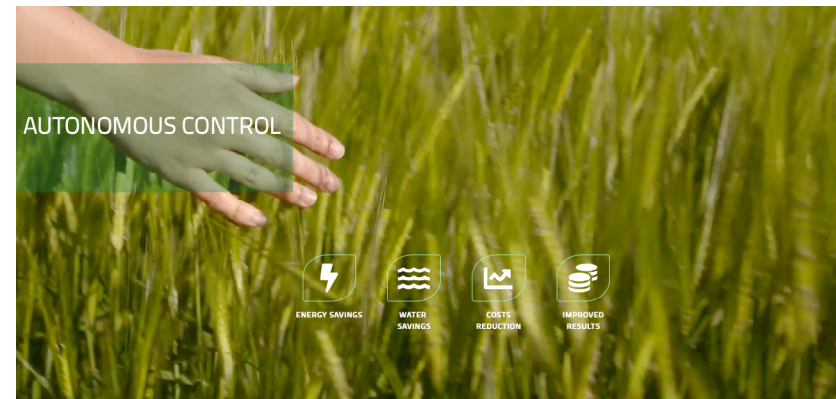

## AUTOMATION SYSTEMS

### Big Idea

The Trigger.Systems platform developed by Rigger enables remote control use of water with savings of 45% in consumption, which is particularly relevant for the agricultural sector and companies who manage large green spaces. The approximately 2,000 irrigation systems that are currently already being controlled by Trigger.Systems, belonging to clients such as the City Councils of Lisbon, Porto and Oeiras, the Calouste Gulbenkian Foundation and the Sovena Group, are the stepping stone for the goal of 30,000 systems set by Rigger for the next 12 months.



**Sector**  
AgroTech

### Team

[Francisco Manso](#) - Founder



## MEET THE WATER-ACTIVATED SELF-HEATING LUNCHBOX

### Big Idea

UZME Everywhere® has developed a lunchbox that allows to heat meals, anywhere, through water-activated heat generating pads, in just 5 minutes. This is possible thanks to the unique combination of minerals contained within the pads, which are capable of releasing the heat necessary to warm a meal, when they come in contact with water. On the other hand, the lunchbox mixes an original design, with modern features, with the thermal efficiency required to achieve a uniform and fast heating. UZME allows the user not to depend on electricity and gas to heat its food, making it easier to follow a healthy regime and have meals outside, so that people are no longer limited to canteens or office kitchens, promoting social distancing.



**Sector**  
E&M

**Activity Highlights**  
Winner of the project TAKE-OFF

**Team**  
[Diogo Lopes](#) – Co-founder  
[João Campos](#) – Co-founder



## KNOW TO CHANGE

### Big Idea

Wakaru® is a technology-based company, focused on developing solutions for the management and analysis of complex events in real time; the creation of 100% digital customer experience ecosystems; software development services or tailor-made integration, innovation and R&D and auditing and consulting in management systems and information technologies. We leverage our innovation capacity to develop new products with an SAP® consulting practice specialized in customer and asset management, supported by SAP® vertical systems: S/4HANA for Utilities, CRM and Digital Supply Chain.



**Sector**  
E&M

**Activity Highlights**  
ADENE – Portuguese Energy Agency, within the scope of the AQUA + prizes “Technologies for monitoring and controlling water use: TECH AQUA + Network”  
Get in the ring – Wakaru® with the Water Wise System® was one of the 20 startups with the most promising solutions to solve the challenges of the 21st century selected for the Get in the Ring Lisboa competition.

**Team**  
[Vitor Prisca](#) – CEO  
[Carlos Oliveira](#) – Head of Business Development  
[Paulo Esteves](#) – Head of Innovation and R&D  
[Sérgio Pinto](#) – Head of Operations  
[João Mugeiro](#) – Head of Utilities Center of Excellence  
[Pedro Cascalheira](#) – Head of Marketing and Communication, Brand Manager





## BE THE REVOLUTION

### Big Idea

We create fully autonomous and decentralized private charging networks for electric vehicles. With We Can Charge any company can create, control and monetize a network of chargers for electric vehicles.



**Sector**  
E&M

### Team

[Ricardo Carvalho](#) – CEO  
[Xavier Rodrigues](#)  
[Isabel Santos Couto](#)

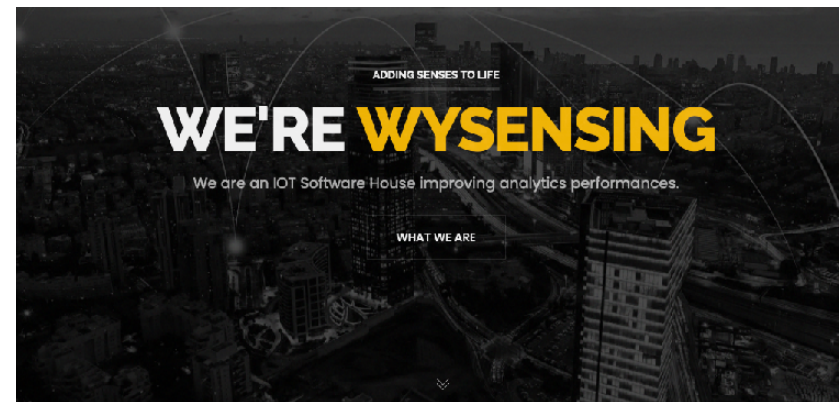

## IOT SOFTWARE HOUSE IMPROVING ANALYTICS PERFORMANCES

### Big Idea

We are a 100% Portuguese company that dedicates itself to explore and develop solutions based on IOT technology – Internet of things. Our purpose is to place Portugal in the front line on one of the markets which has the most worldwide growth potential. IOT technologies represent the third technological revolution, after the internet and smart phones. New ways of communicating and interacting with the market, machines and objects with constant data flow, collection and analyses of data without precedents, new infrastructures of communication... these are some of the realities that we'll be able to assist with soon and that we want to help build.



**Sector**  
E&M

### Team

[Tiago Morais](#) – CEO  
[Pedro Morais](#)





## A GAME CHANGER ON YOUR CAT'S HYGIENE

### Big Idea

Development and commercialisation of innovative products in the area of pets, with its current focus on an innovative and patented (Europe and USA) cat litter box. Development of innovative and patentable Pet Business market products for commercialization.



**Sector**  
Marketplaces

### Team

[Dúnio Couto](#) - CEO & Founder



## CREATING THE BEST SKINCARE IN A POSITIVE AND NATURAL WAY IS OUR MISSION

### Big Idea

YesYesYes is a digital direct to consumer natural skincare brand that provides the right cream for each skin type and the right serum for each skin concerns that the consumer can «Mix & Match» to get their personalized solution. All this while respecting the environment and having minimal formulas that work.



**Sector**  
E&M

### Team

[Ida Bourjouane](#) - Founder & CEO  
[Diogo Campo](#) - Co-founder  
[Alexandre Braga](#) - Co-Founder



# Portfolio

Life Sciences



19  
COMPANIES



36.5  
MILLION EUROS  
INVESTED

since 2012 - new investments and follow-ons

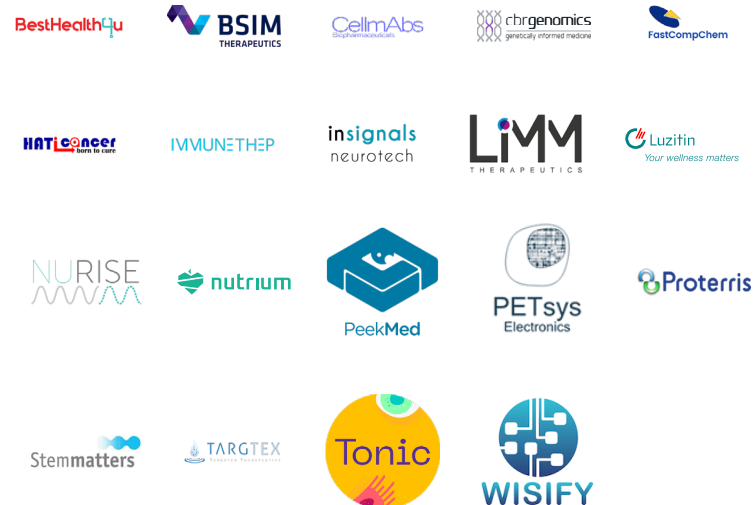

## DEVELOPING NEW AND ADVANCED MATERIALS SOLUTIONS FOR SKIN-INTERACTING MEDICAL DEVICES

### Big Idea

BestHealth4U is an innovative company, specialized in developing new and advanced material solutions for skin-interacting medical devices. As a solution, BestHealth4U developed Bio2Skin, a “firmly-on, glue-less, easy-peel off and skin-friendly” bio-based medical adhesive. Bio2Skin disrupts the current concept of skin adhesion as it is glue-less and does not “stick” to the skin. Instead, it uses the natural features of the skin to establish adhesion through water molecules of the skin, allowing its easy application and safe removal. BestHealth4U’ value is to provide advanced medical solutions to MedTech companies, empowering patients, supporting practitioners, improving clinical outcomes, de-creasing healthcare costs and boosting the Medical Devices industry.



### Sector

Life Sciences

### Activity Highlights

Nourish, 2019  
“Inovação Produtiva” COVID-19, 2020  
Portugal 2020 Research & Innovation COVID-19, 2020  
Portugal 2020 Entrepreneurship R&D “I&D Empresarial: Sistemas de Incentivos à Investigaçao e Desenvolvimento Tecnológico”, 2021

### Team

[Sónia Ferreira](#) - CEO



## INNOVATIVE MEDICINE FOR TRANSTHYRETIN (TTR) RARE DISEASES

### Big Idea

BSIM Therapeutics is an academic spinoff founded in 2011 as a result of scientific research conducted at the University of Coimbra, in collaboration with the University of Leeds, in the United Kingdom. Its mission is to work every day to become a global benchmark in the discovery and development of innovative medicines for the treatment of rare neurodegenerative diseases, focusing particularly on transthyretin-mediated amyloidosis. It contributes to the health and well-being of all patients with ATTR, developing medicines for as yet untreated clinical manifestations, as well as alternative treatments that offer a better cost-benefit ratio compared to those already available on the market.



### Sector

Therapeutics

### Activity Highlights

2013 - Building Global Innovators - Life Sciences Track (semi-finalista runner-up)

### Team

[Rui Brito](#) - CEO

[Carlos Simões](#) - CTO

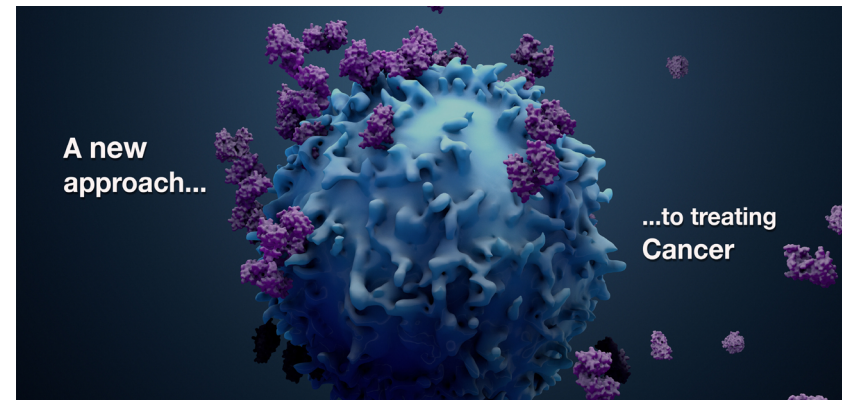

## A LEAP FORWARD IN ONCOLOGY

### Big Idea

CellmAbs is a biopharmaceutical company focused on the discovery and development of the next generation of immunotherapies, the best in class glyco-immuno-oncology drug candidates and personalised treatments. CellmAbs immunotherapies are able to reduce tumor growth and trigger the immune system response by effectively targeting cancer cells in solid tumors with an unprecedented degree of affinity and specificity (does not target normal cells), in both early and late stages. CellmAbs is currently developing 3 programs: a single agent immunotherapy, a CAR-T cell and a Diagnostic device.



### Sector

Therapeutics

### Activity Highlights

Spinoff of NOVA University as a result of years of research that received two national awards (Bluepharma/Universidade de Coimbra Award; Santander/NOVA University)

### Team

[Nuno Prego Ramos](#) - Co-founder and CEO

[Paula Videira](#) - Co-founder



**Sector**  
Digital Health

**Activity Highlights**

2018 - One of the three selected companies to deliver a winner pitch for START(H)UP initiative World Health Summit Regional Meeting - Portugal; Selected by the vote of participants; Selected to present Elsie at QIAGEN's Digital-Pitch event; Top 25 Portuguese technology startups in 2018 (BGI Report)  
2017 - Top 25 Portuguese technology startups in 2017 (BGI Report)  
2015 - Top 3 Biggest Promises in European eHealth

**Team**

[Catarina Gomes](#) - CEO

**GENETICALLY INFORMED MEDICINE**

**Big Idea**

Genetics is still lagging behind within clinical practice, thus hindering the fulfillment of its full potential. This is mainly due to communication and understanding barriers between Genetic Labs, Health Units and Physicians that consequently generate an enormous gap and hinder the usage of genetic tests within clinical practice. Coimbra Genomics aims to fill that gap, as it believes in Genetic Intelligence as an important clinical decision supporting tool. To this end, it has developed Elsie – a platform and marketplace for genetic tests, which simplifies the entire user experience and management of genetic tests within clinical practice. By closing the gap, Elsie will foster the endogenization of genetics in daily clinical practice, with incredible economic, clinical and social benefits.

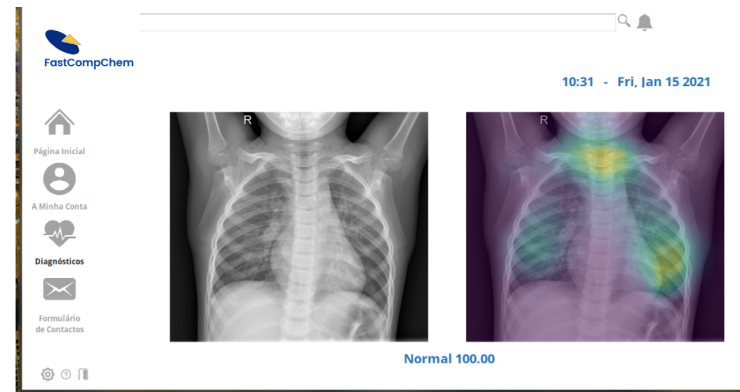

**FAST COVID AND RESPIRATORY DETECTION**

**Big Idea**

FastCompChem develops technologies that enable simulations with tens of thousands of atoms with precise methods ab initio of quantum mechanics. These algorithms can also be used to train databases for artificial intelligence and machine learning, providing new molecular descriptors for use in SAR studies. Fastcompchem is revolutionizing the research process associated with the development of new drugs. Also, FastCompChem developed a solution for diagnosing Covid19 infection that uses Deep Learning to analyse X-ray chest images. It is known that Covid19 infection causes lung abnormalities that can be detected through chest imaging. FastCompChem solution focus on X-ray images (lower radiation) since the technology is also proposed beyond clinical applications.



**Sector**  
Life Sciences

**Team**

[Pedro Lopes](#) – Chief Scientific Officer  
[Sérgio Dias](#) – Chief Technology Officer  
[Vitor Crespo](#) – Board Advisor





## BORN TO CURE

### Big Idea

Something in Hands - Investigação Científica, Lda is a Spin-off from Faculdade de Ciências, Universidade de Lisboa, developing new drugs for metastatic cancer targeted therapy. Currently, our project in breast cancer is in the proof-of-concept phase (WO2016/087932)..



### Sector

Life Sciences

### Activity Highlights

First Place for the project "Rupharma", in ScienceIN2Business Initiative promoted by TecLabs, 2015.  
 "Young Investigator Award", during the Conference "2nd European Conference on Smart Inorganic Polymers", 2015.  
 Scholarship by the programme "Fulbright grant for Portuguese Scholars and Researchers".  
 Private Investment from "Prodigy Bubble" between 2017-2020 to financial support to test in vivo and international patent.  
 Monetary Prize by the Royal Society of Chemistry Research Fund Grant, 2016.

### Team

[Andreia Valente](#) – CEO  
[Helena Garcia](#) – Co-Founder  
[Francisco Simões Rodrigues](#)  
[Rita Tomé Rocha](#)  
[Jorge Maia Alves](#)



## FOR A SAFER TOMORROW

### Big Idea

Immunetep has developed an anti-bacterial immunotherapy based on the discovery of a virulence mechanism shared by a set of different pathogenic bacteria. It discovered that a single molecule (extracellular protein), which is excreted by the pathogenic bacteria, is able to completely shut down the host immune system, letting the bacteria thrive and causing severe infections. Thus, by neutralising this molecule it can induce protection. By addressing an extracellular virulence factor that is highly conserved in the different bacteria, the company's anti-bacterial immunotherapy elicits protective antibodies against all the serotypes of the referred bacterial pathogens. It will, thus, also prevent the emergence of strains which are not addressed by current vaccines and which only address structural epitopes.

# IMMUNETEP



### Sector

Therapeutics

### Activity Highlights

2017 - Empreendedor XXI Award "startup most promise in the life sciences sector"  
 Grant from the Bill & Melinda Gates Foundation

### Team

[Bruno Santos](#) – CEO & Co-Founder  
[Pedro Madureira](#) – CSO & Co-Founder



## IMPROVE THE HEALTH OF PEOPLE WITH NEUROLOGICAL DISEASES

### Big Idea

inSignals Neurotech is a spin-off of the R&D Institute INESC TEC, together with Frontier IP Group. The company will explore technologies based on microengineering that enhance therapeutics approaches when dealing with neurological pathologies. The products being developed are designed after hearing the demands from doctors that require solutions to improve the precision of motor symptoms analysis, to support better therapeutics. The first product that will enter the market is iHandU to evaluate motor rigidity objectively and support Deep Brain Stimulation therapy of patients with Parkinson's Disease. The vision of inSignals is to improve the health of people with neurological diseases

insignals  
neurotech



**Sector**  
Life Sciences

### Activity Highlights

i3S-Hovione Capital Innovation Prize – First Place  
EIT Health Start-ups Meet Pharma – Second Place  
Recognition as EIT Health “Rising Star company”  
The Spinoff Prize – Nature Research Award in partnership with Merck – honorable mention as “Ones to Watch 2020”

### Team

[Sara Reis](#) – Diretora-Geral  
[João Paulo Cunha](#) – Scientific Chief Advisor



## DECODING THE LANGUAGE OF THE NEUROIMMUNE CROSS-TALK

### Big Idea

LiMM Therapeutics is a biopharmaceutical company harnessing the molecular crosstalk between neuronal and innate lymphoid cells (ILCs) within peripheral tissues. By decoding the language of the neuro-immune crosstalk, we are developing first-in-class therapeutic products – NRILs: neuronal reprogrammers of innate lymphocytes – to preserve health and treat inflammatory and metabolic diseases and cancer. We are bridging neural sensing and immunology discoveries to unlock therapeutic solutions for the benefit of patients.

LiMM  
THERAPEUTICS



**Sector**  
Therapeutics

### Team

[David Braga Malta](#) – Founder  
[Henrique Veiga-Fernandes](#) – Founder

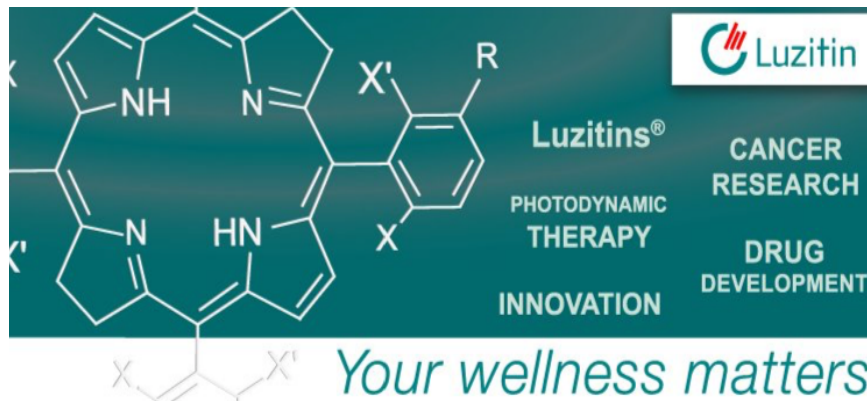

**Luzitin**  
Your wellness matters

Luzitins®  
CANCER RESEARCH  
PHOTODYNAMIC THERAPY  
DRUG DEVELOPMENT  
INNOVATION

## YOUR WELLNESS MATTERS

### Big Idea

A game-changing new generation of photosensitizers (Redaporfin) in the Oncology field, which can bring photodynamic therapy (PDT) into routine daily practice for the targeted therapy of solid tumours.



### Sector

Therapeutics

### Activity Highlights

Orphan drug designation granted by EMA and FDA  
Safety and efficacy results in advanced Head & Neck Cancer patients

### Team

[Sérgio Simões](#) – Chairman & CEO  
[Cláudia Silva](#) – COO/Deputy CEO  
[Luís Almeida](#) – Chief Medical Officer  
[Tobias Silva](#) – Business Development



**INNOVATIVE  
RADIATION DETECTORS**

## HELPING DOCTORS BETTER TARGET THE CANCER, PROTECTING PATIENTS FROM UNNECESSARY RADIATION

### Big Idea

NU-RISE is driving the next-generation of radiotherapy by empowering doctors “to see while treating”. NU-RISE provides real-time patient dose tracking for adaptive radiotherapy helping doctors to deliver safer and accurate radiation therapy in less treatment sessions. By monitoring in real-time the level of radiation being delivered near the tumor and surrounding organs at risk and combining this valuable data with NU-RISE’s adaptive software, it’s possible to perform treatment adjustments every time a deviation occurs. Doctors can better target the cancer while protecting patients from unnecessary radiation and avoiding severe secondary effects. It’s an evolution for cancer treatment—faster, personalized, and safer cancer treatments.



### Sector

Life Sciences

### Activity Highlights

Eit Health Bridgehead Global, 2020  
Maze X accelerator, 2020  
Born From Knowledge Prize – ANI, 2019  
Eit Health Headstart, 2019

### Team

[Luís Moutinho](#) – CEO  
[Joana Melo](#) – COO





## THE FUTURE OF NUTRITION COUNSELLING AND CLIENT RETENTION

### Big Idea

Nutrium is a nutrition software designed for dietitians and their patients aimed at improving the follow-up (nutritional monitoring) of the professional with their patient, in the period between appointments. Later on, the company aims to leverage its network of dietitians and data to automate the clinical nutrition marketplace.



**Sector**  
Digital Health

### Team

[André Santos](#) - CEO  
[Diogo Alves](#) - COO  
Pedro Carneiro - CTO  
[Pedro Maia](#) - CFO



## A POWERFUL 3-D PRE-OPERATIVE PLANNING SOFTWARE FOR ORTHOPEDIC SURGERY

### Big Idea

PeekMed is a patent-pending 3D pre-operative planning system for orthopedic surgery to help surgeons improve outcomes, while reducing costs.



**Sector**  
Digital Health

### Activity Highlights

CE and ISO:13485 certified and FDA approved  
3rd place in ZimmerBiomet's Connected Health Award.

### Team

[João Pedro Ribeiro](#) - CEO  
[Sara Silva](#) - COO  
[Jaime Campos](#) - CTO



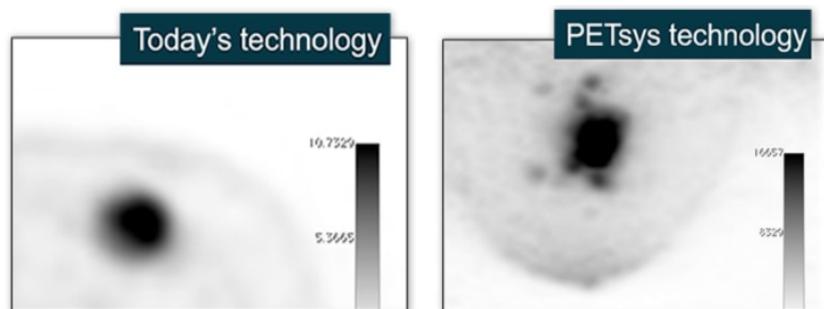

## ELECTRONICS FOR THE NEW PET TECHNOLOGY FOR CANCER DETECTION

### Big Idea

PETSys' positioning is to sell PET Detector Modules and complete PET readout systems for PET scanners and other applications. PET – Positron Emission Tomography, is a benchmark medical imaging technique in cancer detection. PET images are obtained using PET scanners. PET detector cost accounts for 30-35% of a PET scanner sales price.



**Sector**  
MedTech

### Team

[João Varela](#) – Co-Founder & CEO  
[Vasco Varela](#) – Co-Founder & Executive Board Member  
 Steffaan Tavernier – Co-Founder & CTO

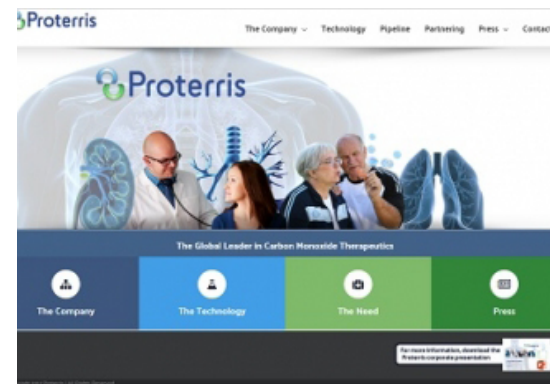

## THE GLOBAL LEADER IN CARBON MONOXIDE THERAPEUTIC

### Big Idea

Proterris is a clinical development stage company focused on therapeutic applications of low-dose carbon monoxide. Leveraging carbon monoxide's (CO) demonstrated anti-fibrotic, anti-inflammatory and cytoprotective properties, Proterris initially focused on developing CO therapies for delayed graft function (DGF) in renal transplant recipients and idiopathic pulmonary fibrosis (IPF). Other indications (pulmonary arterial hypertension and acute respiratory distress syndrome) are also being developed by the National Institute of Health (NIH). In short, CO has enormous potential to significantly impact the lives of millions of patients suffering from a wide range of acute and chronic diseases.



**Sector**  
Therapeutics

### Team

[Jeffrey Wager](#), M.D., Chairman & CEO  
 Augustine Choi, M.D., Scientific Co-Founder



## NON-INVASIVE CANCER PROGRESSION MONITORING

### Big Idea

RUBYnanomed is a spin-off from the International Iberian Nanotechnology Laboratory (INL), founded to bring to the clinical market the RUBYchip™: the first non-invasive and easy-to-use cancer progression monitoring device that isolates circulating tumour cells (CTCs) through liquid biopsy directly from whole blood samples. RUBYchip™ will provide the oncologists with a new tool for better monitoring of metastasis, enabling better therapeutic decisions, and thus improving the life of cancer patients.



### Sector

Life Sciences

### Activity Highlights

Elevator Pitch Competition (EPIc), First prize – health technologies. Organised by Hong Kong Science and Technology Parks Corporation (HKSTP), Hong Kong, 2020  
Industry Award, INL, PT, 2020  
IPA4SME, European Commission for Seal of Excellence projects in EIC funding call, PT/EU, 2020  
Winner of the Royal Society of Chemistry Emerging Technologies Competition in the category of Health, London, UK – first prize, UK, 2019

### Team

[Lorena Diéguez](#) – CEO  
[Enrique Sanchez](#) – CBO  
[Sara Abalde-Cela](#) – CTO  
[Paulina Piairo](#) – COO

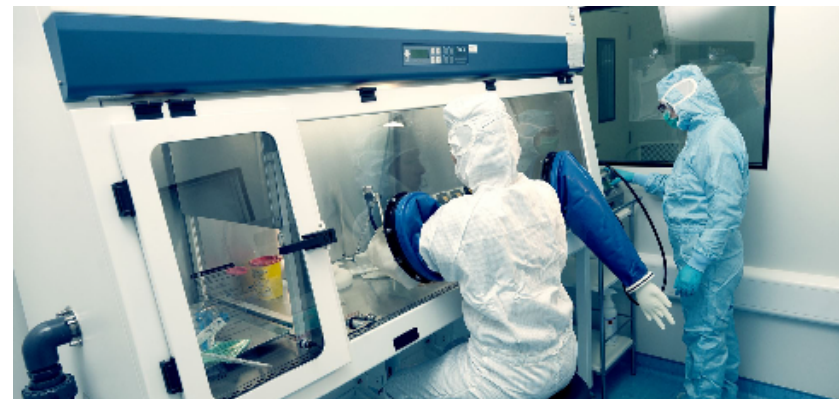

## R&D AND MANUFACTURING OF REGENERATIVE MEDICINE PRODUCTS

### Big Idea

Stematters is a Portuguese biotechnology company developing biomaterials and devices for regenerative medicine. The company has designed a novel injectable medical device to be used in the repair of articular cartilage lesions which aims at providing significant advantages as compared to current methods of treatment. This device aims at providing in situ regeneration of hyaline-like cartilage tissue, being implanted by a minimally invasive and simple (procedure) to reduce hospitalisation costs.



### Sector

Contract Research and Manufacturing

### Team

[Rui Amandi Sousa](#) - CEO

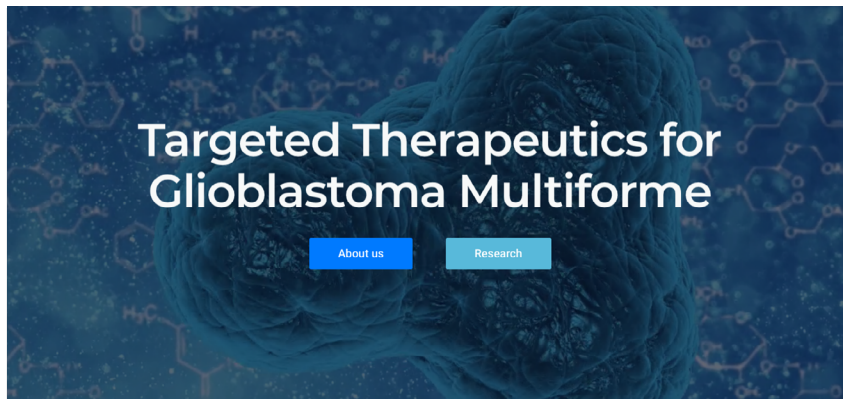

## TARGETED THERAPEUTICS

### Big Idea

TargTex is a drug development company focused on developing clinical candidates for different therapeutic indications. The company's most advanced product is a therapy for Glioblastoma Multiforme (GBM), the most aggressive type of brain tumor with high lethality and considered an unmet medical need. This product is based on a natural product with a specific formulation that already demonstrated high efficacy in pre-clinical animal models of the disease.



**Sector**  
Therapeutics

### Activity Highlights

The best of 2019 in Technological Portugal” from Exame Informática magazine, honourable mention in the Software category  
Patent: WO/2019/054891 TRPV2 Antagonists

### Team

[João Seixas](#) – CEO  
[Pedro Cal](#) – COO  
Gonçalo Bernardes – Scientific Director

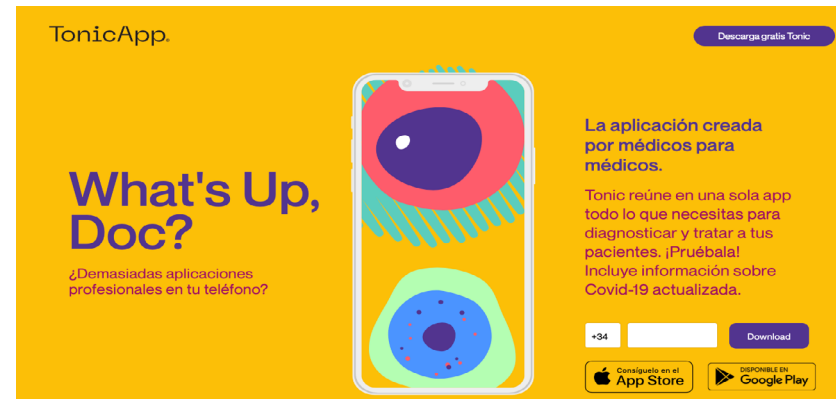

## SMARTER IN-STORE SHOPPING EXPERIENCE

### Big Idea

TonicApp's goal is to digitally streamline healthcare, while keeping it humane and to be the go-to professional mobile app for all stakeholders in healthcare, helping healthcare professionals be happier and more productive at their jobs. It is innovative, while having the courage and resilience to face the complexity of the healthcare industry, all while taking the time to understand what ails the healthcare professional, as well as their needs.



**Sector**  
Digital Health

### Team

[Daniela Seixas](#) – CEO



## EMPOWER PROFESSIONALS TO IMPROVE PEOPLE'S LIVES

### Big Idea

The assessment of body fat has a great impact in body fit and wellbeing, namely in nutrition, health and sports. Wisify - Tech Solutions is a Spin-off of the University of Porto, established in August 2018, which is dedicated to the development, manufacture and commercialization of Lipowise, the most advanced digital skinfold calliper in the global market. Lipowise is a smart tool for rigorous and fast body fat assessment, for faster, low-cost and accurate localized body composition assessment for use by professionals in health and sports areas. Lipowise is portable, and communicates via Bluetooth with its own applications, having been granted patents in the largest European markets and in the United States.



### Sector

Life Sciences

### Activity Highlights

Cárdio Med.Ideas Award 2018  
EIT Headstart Award 2019  
Selection to the Qatar Sports Tech Accelerator 2020

### Team

[Ricardo Moura](#) - CEO & Co-Founder  
[Tiago Andrade](#) - CTO  
[Eduardo Mouta](#) - Sales Director



## Portfolio

Tourism



26  
COMPANIES



24.7  
MILLION EUROS  
INVESTED

since 2012 - new investments and follow-ons

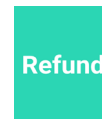





## SUN, SEA AND SUSTAINABILITY

### Big Idea

Algarve Sun Boat Trips is the first touristic company in the Algarve operating with an 100% ecological fleet, without any carbon emissions, using electro-solar ships, enabling comfortable, silent and, above all, environmentally friendly tours. They between Portimão and Silves, on the river Arade, offering several unique products. They are now heading towards the ocean, operating also along the coastline, between Benagil and Alvor, continuing to provide an innovative product, with unique features, recognisable for its superior quality.



### Sector

Tourist Entertainment Company

### Team

[Pedro Mestre](#) - CEO & Founder

[Ricardo Gonzalez](#) - CMO



## DRIVERS OF TOMORROW

### Big Idea

The Algarve International Circuit leverages the Algarve's weather and hotels to offer all players in the motorsport industry, from manufacturers to top racing teams, all the facilities they need to test, develop, present and launch their products.



### Sector

Tourist Entertainment Company

### Team

[Paulo Pinheiro](#) - CEO

[Jaime Costa](#) - CFO

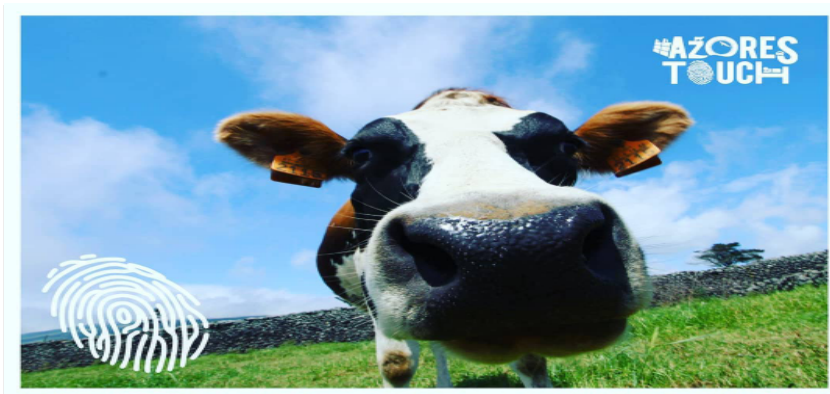

## BOOK YOUR AZORES HOLIDAYS!

### Big Idea

Azores Touch is a company created in 2016 by CEO Sérgio Cota, and is represented by a young and dynamic team. The areas of the company include rental car, tourist entertainment and the large slice that is the management of local accommodation. The purpose of this company is to provide the best possible experience for those who visit them from arrival to departure by demonstrating as much possible of what is local. Our mission is to facilitate access to all available services and activities (some of them which are exclusive!) so that people's holidays, in contact with our nature, culture, history and people are unforgettable. It's headquarters is on Terceira Island and has already expanded to Graciosa Island. In the future they intend to expand to other islands and reach a wider range of people.



### Sector

Tourist Entertainment Company

### Team

Sérgio Cota - CEO



## SAVE ON YOUR LUGGAGE AND SPEND IT ON YOUR TRIP!

### Big Idea

Bag4days is a luggage rental company that allows travellers to travel with well-known and secure luggage. You can rent luggage suitcases or specific suitcases to carry wine or bicycles. The suitcase can be delivered and/or collected at any European address.



### Sector

Enterprise

### Team

Rúben Marques - CEO & Founder



## IT'S ALL ABOUT PEOPLE!

### Big Idea

Classihy reinvents today's reviews and performance systems creating a smart community and a revolutionary real-time performance tool, valuable for all. Classihy is a digital platform where customers can easily give their feedbacks confidentially and individually to the staff members, transforming their experience and employees can improve by themselves and participate in a gamified performance system, where they build confidence and get rewards and managers access a unique, accurate and real-time to monitor and improve the performance of their team.



**Sector**  
Enterprise

### Activity Highlights

From-Start-To-Table Acceleration Program  
Finalist  
Winner of Disruption Open Innovation Program  
from Group Nabeiro

### Team

[Ariane de Melo](#) – Co-Founder & CEO  
[Miguel de Melo Ramos](#) – Co-Founder & Director  
of sales and marketing  
[Vitor Hipólito](#) – Co-Founder & Strategic  
partnerships



## THE KEY TO ÉVORA

### Big Idea

Convento do Espinheiro Historic Hotel & Spa mission is to take a leading national and international luxury hotel. The company is committed to continuous improvement, while cherishing a true passion for service excellence and striving to exceed guests' expectations. It values its staff and, through training and by encouraging innovative ideas, it fosters professional and personal development. The company supports initiatives that contribute to the improvement of the surrounding community and environment. It aims to make work gratifying and maintain honesty and integrity in all its relationships.



**Sector**  
Innovative Accomodation

### Team

Alexandre Palma – GM  
Ricardo Barreto – Sales Manager  
Hugo Silva – Executive Chef  
João Mariano – F&B Manager  
Davide Abacate – FOM  
Amélia Santos – Executive Housekeeper  
Ricardo Banha – eCommerce & Revenue Manager  
Reginaldo Felizardo – Maintenance Supervisor  
Carla Moleiro – Spa Supervisor  
Filipa Oliveira – Operational Manager

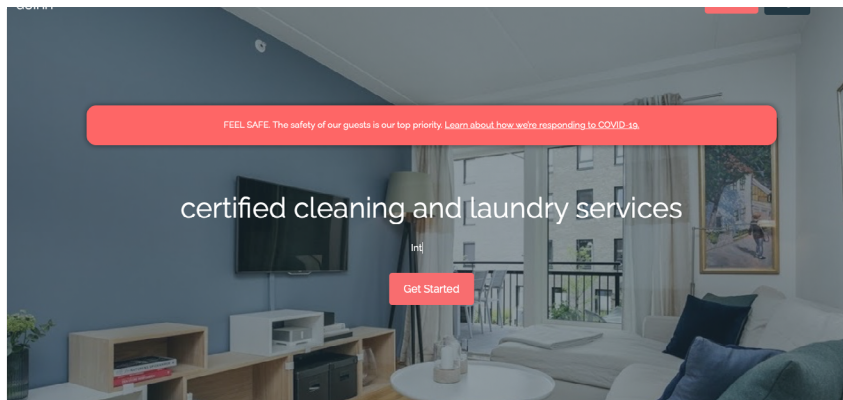

## CLEANING AND LAUNDRY MANAGEMENT TOOL FOR SHORT AND MID RENTAL HOSTS

### Big Idea

DoInn is all the help you will ever needed. It brings local accommodation owners or managers into contact with the best cleaning and laundry services. To do this, it uses a thorough, highly professional platform with a service that is always, at the very least, spotless.

doInn<sup>•CO</sup>



**Sector**  
Marketplaces

### Team

[Noelia Novella](#) - CEO  
[Nuno Rodrigues](#) - CPO  
[Weronika Figueiredo](#) - CMO



## SO SIMPLE AND SO GOOD

### Big Idea

EatTasty is the digital platform for making and delivering meals designed to streamline the selection process and improve the experience of those who enjoy eating well and on time, without having to spend too much time thinking about it. Easy to choose, simple to order. Free delivery. Freshly made lunch and dinner, delivered on time and wherever you are, from monday to friday.



Tão simples e tão bom.



**Sector**  
Marketplaces

### Activity Highlights

Winners of the Lisbon Challenge from Beta-i, 2016  
The hottest startups in Lisbon by Wired 2019

### Team

[Rui Costa](#) - Co-Founder & CEO  
[Orlando Lopes](#) - Co-Founder



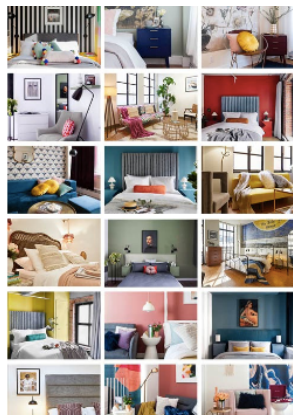

## Meet Fülhaus!

Fülhaus is a turnkey interior design company offering a Haus-in-a-Box solution for the short term rental industry. Fülhaus explores the removal of barriers, focusing on design quality, economics of scale and delivery systems to offer interior-design-as-a-product.



## Fülhaus



**Sector**  
Enterprise

**Team**  
[Andria Santos](#) - CEO

## GOOD DESIGN EVERY STAY

### Big Idea

Fülhaus is a turn-key interior design company offering a Haus-in-a-Box solution for the short-term rental industry. Fülhaus explores the removal of barriers, focusing on design quality, economics of scale and delivery systems to offer interior-design-as-a-product. Since its inception in 2015, Fülhaus has refined the art of designing and furnishing short-term rentals into the Haus-in-a-box product — everything you need for your short-term rental, delivered, installed, and photographed at an affordable monthly fee. With six Fülhaus signature styles that are ever adapting to interior trends, this product offering has simplified the way clients can furnish their rentals. Fülhaus strives to design interiors that will adapt and evolve alongside its clients and their environment.



**Sector**  
Enterprise

**Team**  
[Pedro Colaço](#) - CEO  
[Armando Rocha](#) - VP Development  
[Rita Alves Machado](#) - VP Sales and Marketing

## THE BRAND OF CHOICE FOR INDEPENDENT UPSCALE HOTELS

### Big Idea

Great Hotels of the World is an international hotel representation company that offers reservation, sales and marketing services, as well as innovative technological solutions, to an exclusive portfolio of nearly 60, mostly independent, hotels and resorts worldwide. The services of GHOTW are tailored to the needs of each hotel and this personalised approach ensures that each one maintains its personality and authenticity while accessing distribution channels, leading technology and new markets. The company headquarters is in Lisbon, Portugal.

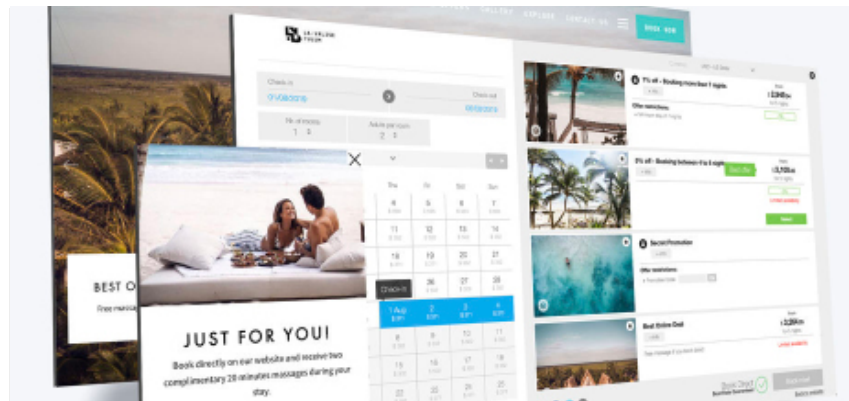

## DIRECT RESULTS THAT EXCEED EXPECTATIONS

### Big Idea

GuestCentric is a leading provider of cloud-based digital marketing software and services that help extraordinary hoteliers promote their brand, drive direct bookings and connect with customers on all digital platforms. GuestCentric's all-in-one platform provides hotels with the only unified solution for managing their guests' online journey: award-winning, high impact websites; an integrated, easy-to-use booking engine; social media marketing and publishing tools; a GDS chain code and a channel manager to offer rooms on Amadeus, Booking.com, Expedia, Galileo, Google, Sabre, TripAdvisor and hundreds of other channels.



### Sector

Enterprise

### Activity Highlights

Adrian Awards  
AVA Digital Awards  
Davey Awards  
dotCOMM Awards  
Emerging Media Awards (EMA)  
Hermes Awards  
Horizon Interactive Awards  
Interactive Media Awards (IMA)  
Stevie Awards  
Summit International Awards  
WebAwards  
The Communicator Award

### Team

[Pedro Colação](#) – President & CEO  
[Filipe Machaz](#) – Vice President of Sales  
[João Trindade](#) – Vice President of Marketing & Product



## AI-POWERED CHATBOY AND COMMUNICATION PLATFORM FOR HOTELS

### Big Idea

HiJiffy is an innovative solution that centralizes, automates, and measures all hotel customer service activities, integrating innovative technology in a simple, reliable, and robust platform, used daily in more than 1400 hotels, in 30 countries. The hotels using HiJiffy have an average automation rate of 80%, being fundamental in a time when the guest's contacts are more and more complex. With HiJiffy hotels can ensure that they will have instant replies 24/7 digital.



### Sector

Enterprise

### Activity Highlights

UNWTO – More innovative Solution in Tourism, 2020  
Entrepreneur Award BPI and Caixa Bank, 2020

### Team

[Tiago Araújo](#) - CEO & Co-Founder  
[Pedro Gonçalves](#) - COO & Co-Founder  
[José Mendonça](#) - CTO & Co-Founder

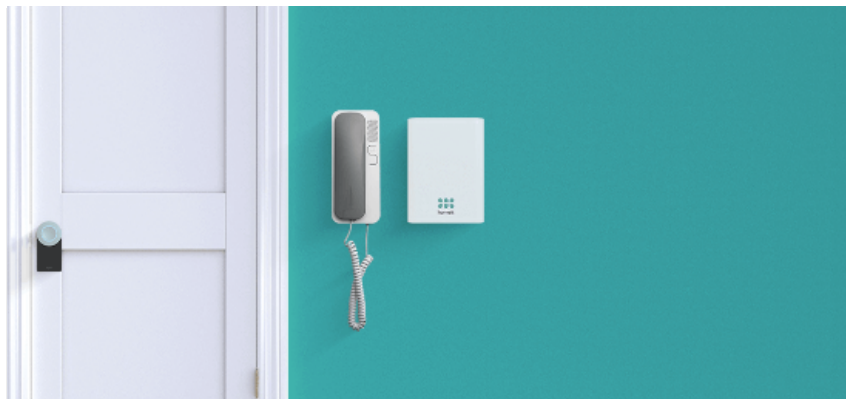

## THE SMARTLOCK FOR RENTAL HOMES

### Big Idea

Access to properties is one of the biggest headaches for local lodging owners and guests, as adjusting schedules can often be difficult. Homeit offers a smart lock that opens doors using a code created by the owner or via an app, thus bypassing the need for a regular key. Property owners can, therefore, create personal keys for their guests/holiday makers, staff and maintenance crews remotely and online. Europe currently has a market of 5 million local lodging establishments and Homeit is present in 15 countries, with almost 2,900 active boxes.



**Sector**  
IOT

### Team

[André Roque](#) - CEO

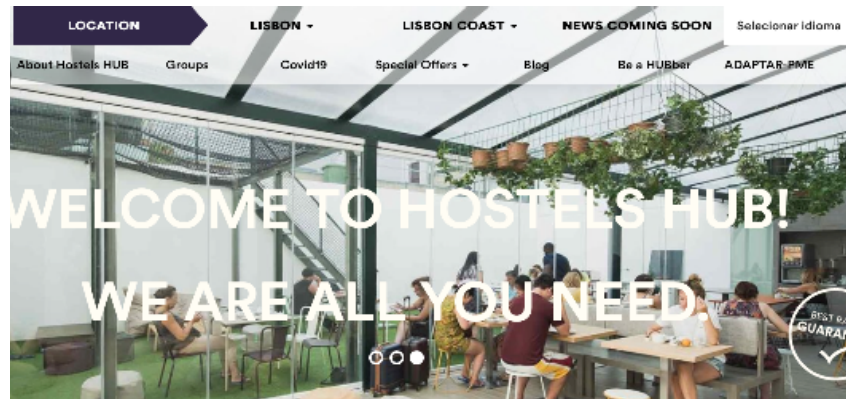

## THE BIGGEST HOSTEL GROUP PLAYER IN PORTUGAL

### Big Idea

Hostels HUB Group is a project aimed at the development of a network of hostels distributed in the Iberian Peninsula, through medium and large projects with two brands: HUB and AKTION. The Hostels HUB Group is a project that aims to develop a network of hostels distributed in the Iberian Peninsula, through medium and large units, with the two associated brands: HUB (Urban / Culture) and AKTION (Activities / Leisure). It is currently one of the largest national chain of hostels, several units already, designed and prepared to receive groups, families or even lonely adventurers with properties at Lisbon, Ericeira and . We provide a wide range of programs designed specifically to make our Guests' experience unforgettable and capable of exceeding all expectations. We reinvented the traditional hostel idea and offer quality, comfort, security and, above all, tranquillity to all our customers.



**Sector**  
Hospitality

### Activity Highlights

8 of the Best Budget Places to Stay in Lisbon  
TripAdvisor Traveler's Choice 2020 – Hub New Lisbon  
TripAdvisor Traveler's Choice 2020 – Aktion Ericeira Surf Hostel  
Best Hostels Portugal 2020 – Aktion Ericeira Surf Hostel  
Best Hostel 2020 Kayak Portugal – Hub New Lisbon  
Prémio Excelência IAPMEI – 2018 e 2019  
Prémio da melhor novidade do ano na cidade de Lisboa

### Team

[Nuno Constantino](#) – Developer  
[Tiago Almeida](#) – Assistant Manager  
[Susana Ferreira](#) – Operations Manager  
[Angelica Carneiro](#) – Director of Sales  
[Guilherme Lavos](#) – Financial Director



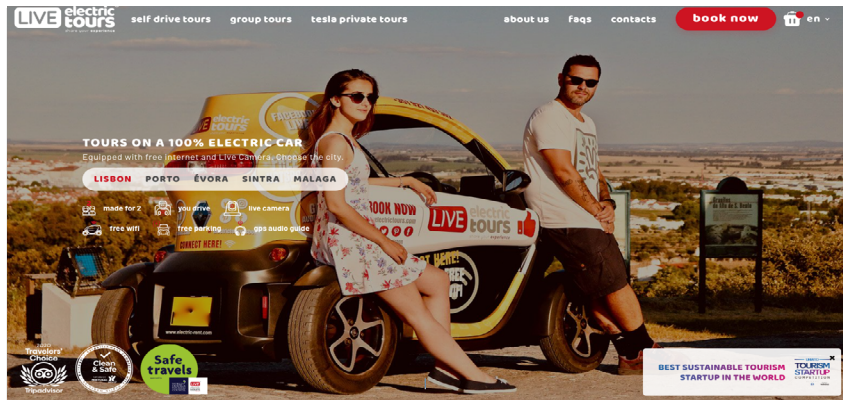

## SHARE YOUR EXPERIENCE

### Big Idea

Live Electric Tours is a self-drive experience using 100% electric vehicles for tourists in Lisbon, Porto and Évora. The company opened its doors in August 2017. Its vehicles are unique as they come equipped with free Wi-Fi, a GPS Audio Guide with pre-programmed routes and a live camera so that users can share their entire experience live directly to social media.



### Sector

Tourist Entertainment Company

### Team

[Djalmo Gomes](#) - CEO & Founder

[Luis Lucas](#) - COO & Co-Founder



## TIME MATTERS

### Big Idea

LUGG it is a technology platform that allows travellers, using a mobile app (available for iOS and Android), to make a real-time request for someone to collect their luggage, store it and deliver it to the place and at the time they indicate.

LUGG it



### Sector

Marketplaces

### Activity Highlights

Winners of the NEWTON acceleration program, promoted by Turismo de Portugal  
TOP 20 Awards by Startup Lighthouse, promoted by the European Commission  
Finalists of The Journey Acceleration Program, promoted by Beta-i

### Team

[Ricardo Figueiredo](#) - CEO

[Diogo Correia](#) - COO

[João Pedro Pedrosa](#) - CTO

[Hugo Fonseca](#) - Head of Software Development



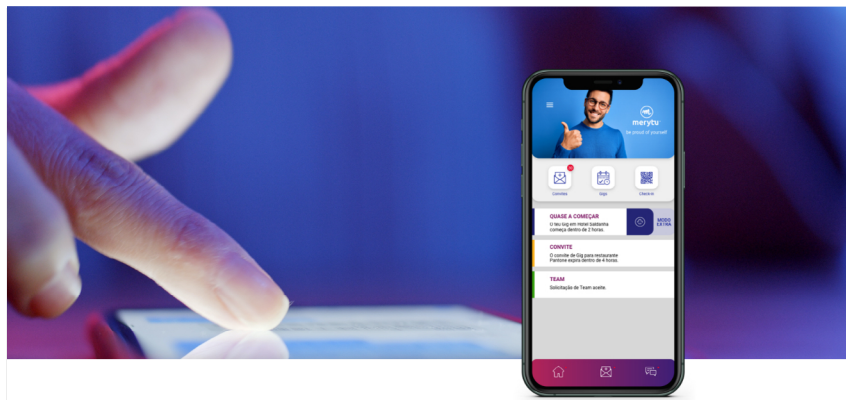

## CONNECTS PROFESSIONALS AND COMPANIES FROM HOSPITALITY SECTOR IN A SIMPLE, INNOVATIVE AND EFFICIENT WAY

### Big Idea

It enables companies from Hotel and Restaurant industry to reinforce teams with qualified professionals during the specific period of workforce needs. In an intuitive and transparent approach, this model automates profile matching, insurance, payments, and any other administrative or legal tasks. To companies from Hotel and Restaurant sectors, merytu it's a brand-new reality where the cost efficiency, the reduction of time losses, and the performance-focused selection of professionals welcome a whole new competitive edge. Regarding professionals, merytu allows an epic lifestyle, where the career journey is drawn by themselves, with above-average earnings, and unprecedented evolution possibilities.



**Sector**  
Hospitality & Marketplaces

### Team

[Francisco Nogueira de Sousa](#) - Co-Founder & CEO  
[João Silva Santos](#) - Co-Founder & COO  
[Ronaldo Marques](#) - Co-Founder & CTO  
[Manuel Ferreira Mendes](#) - Co-Founder & CLO



## NATURAL SKINCARE PRODUCTS

### Big Idea

Oliófora is a small industrial company which extracts high-quality cold pressed vegetable oils and manufactures natural cosmetics by combing these oils with herbal extracts, algae and flower essence. Its products are primarily for the hotel industry, SPAs and wellness centres, and for sale to the public. Its target-market are boutique hotels, luxury eco-resorts and small hotel chains. The company's products are already available in hotels and SPAs in Douro, the Algarve and Lisbon.



**Sector**  
Others

### Team

[Daria Maximova](#) - CEO

## Refundit

Welcome To The New World Of

100% Digital  
TAX-FREE  
SHOPPING



### REVOLUTIONIZING TAX-FREE SHOPPING FOR TOURISTS

#### Big Idea

Refundit is a VAT refund platform for non-EU citizens that simplifies and digitises the current process, doing away with paperwork and lines and, thereby benefiting holidaymakers and governments. In January 2019, Refundit won the first edition of the Start-up Competition held by the UN World Tourism Organisation.

Refundit



Sector  
SaaS

#### Team

[Ziv Tirosh](#) - CEO



### THE TECH COMPANY THAT RENTS BOATS

#### Big Idea

Sailside helps boat owners monetize their boats through boat rentals. It is the only peer to peer boat rental marketplace in Portugal and has the most engaging approach to monetize boats. J. P. Morgan said that if you need to ask what the price of a yacht is, you probably can't buy it. This is where Sailside comes in!



#### Sector

Marketplaces

#### Activity Highlights

1st place at the national level of the 1st edition of Tourism Explorers, the largest tourism acceleration program in Portugal  
3rd place in the Babson Challenge

#### Team

[João Maria Vasconcelos Vilas Boas](#) - Strategy, Fundraising, Communication  
[Pedro Canedo](#) - Head of Operations  
[Pedro Lourenço](#) - Finance, Strategy, Process Optimisation  
[Ricardo Lobo](#) - Head of Tech Development

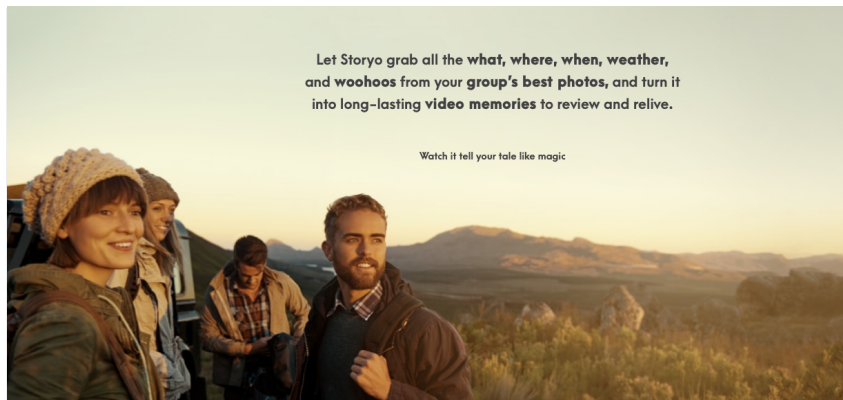

## LEVERAGING THE POWER OF DATA-DRIVEN STORYTELLING

### Big Idea

Storyo is a free mobile app that automatically creates video stories from photos on a smartphone. The app uses a patented algorithm that creates a narrative using data from any number of photos and enriches it with contextual information from the internet, so that each video tells its own story. In 2013, Storymatik applied for a patent for its technology entitled "Systems and methods for automatic narrative creation". This technology is what drives Strips and Storyo and its ability to interpret a set of photos and create narratives automatically. The patent was granted in the United States by the United States Patent and Trademark Office.



**Sector**  
Mobile

### Team

[Filipe Vasconcelos](#) - CEO  
[Leonel Duarte](#) - CCO  
[Manuel Costa](#) - CTO



## TAKING LUXURY VACATION RENTALS TO A NEW LEVEL

### Big Idea

Tripwix is a luxury travel brand for demanding customers. It operates as an online travel agency where all establishments are kept to the highest standards of curatorship. Homes are personally inspected by Tripwix interior designers, thus guaranteeing customer satisfaction. Short-term rentals have been on the rise, as have the demands of customers who are looking for unique family experiences, and currently represent a US\$57-billion market worldwide. Tripwix is currently operating in Portugal, Mexico, Spain, Italy and Turkey.



**Sector**  
Marketplaces

### Team

[José Murta](#) - CEO



Genuine Lands for  
Life experiences

NATURAL WORLD | ADVENTURE & SPORT | CULTURE & HISTORY

Outdoor holiday programs, trips & experiences

see more [www.tryportugal.pt](http://www.tryportugal.pt)  
info@tryportugal.pt

## GENUINE LANDS FOR LIFE EXPERIENCES

### Big Idea

TRY PORTUGAL, a brand owned by Upstream, is an Incoming Touristic Operation (DMC) specialized in Active, Cultural & Sports Tourism. It designs and promotes new thematic touristic products and sports events that incorporate the country's heritage assets and Natural & Cultural Resources and develops products and services that contribute to enhance and reinforce Portugal's tourist attractiveness in the main international issuing markets. TRY PORTUGAL, provides, via its digital marketplace, an integrated offer of a wide range of experiences & activities of local services providers and hospitality partners from all the country, thus facilitating the research and distribution of products to International Tour Operators and Agents (B2B), positioning Portugal as a destination of excellence for Active, Cultural & Sport Tourism 365 days a year!



**Sector**  
Tour Operator

### Activity Highlights

2017 and 2018 - ALPHA Program WEB Summit  
by Startup Portugal.

### Team

[Catherine de Freitas](#) – Founder, RP & CEO  
[Sérgio Mendes](#) – Founder, Director IT & Board Member  
[Fernando Completo](#) – Board Member  
[Paulo Passos Leite](#) – Board Member  
[Paulo Cavaleiro](#) – Project Leader



## NEED A BREAK?

### Big Idea

With the objective of creating unforgettable moments in beautiful places, Wide Ocean Retreats helps event organisers from all over the world in the planning and organisation of group retreats in Portugal. Functioning as a co-organiser, the team supports in the choice of the perfect event venue, the organisation of unique experiences, transport and other factors that contribute to the success of the retreat. Their website will display their carefully selected and tested partners and will connect organisers with the facilities and services that are needed for their type of retreat. Given their experience as retreat organisers, Antonio and Lisa are aware of the points of success and failure of a retreat and aid in providing the perfect retreat experience to their clients.



**Sector**  
Tour Operator/Tourist Entertainment  
Company

### Activity Highlights

First Place at the Tourism Explorers Programme  
by Fábrica de Startups

### Team

[António Martins](#) - CEO & Co-Founder  
[Lisa Lohmann](#) - Manager



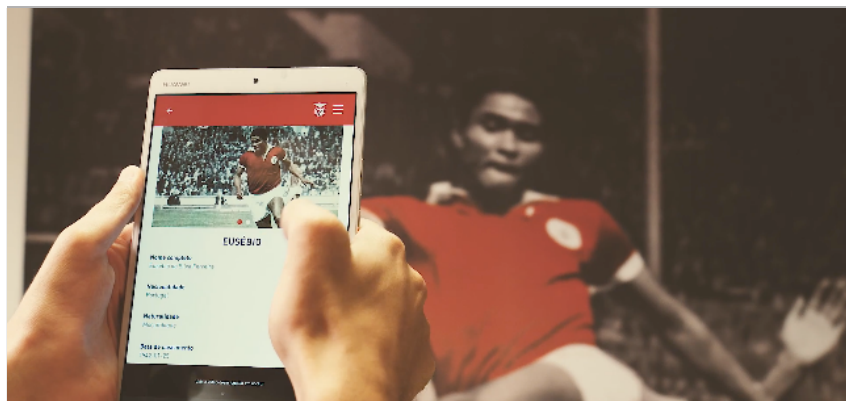

## LEVEL UP THE EXPERIENCE

### Big Idea

The X-PLORA app guides users throughout a Venue or a City in a totally interactive and immersive way. As the visitors move around, the APP provides customized information/content, determined by the user's exact location, profile and interests. With features of Geo-Referencing, Virtual and Augmented Reality, 3D Sound, Gamification and inclusive Visits for different kinds of visitor profiles, X-PLORA takes the visitor experience to the next level.

X-PLORA



### Sector

Tourist Entertainment Company

### Activity Highlights

Finalist of The Stadium Business Summit 2019 in the "Fan Experience Award" category, held in Manchester, UK with the app Benfica Tour 360 App

Selected as partner of the Change the Game initiative in the "Excellent Experiences" category, held in the Amsterdam ArenA in 2019

### Team

[Mafalda Ricca](#) - Founder & CEO

[Lourenço Cunha Ferreira](#) - Founder & Creative Director

[Luís Agrellos](#) - Founder & Technical Advisor

[Martim Pessanha](#) - Founder & Commercial Advisor



## ACCELERATING YOUR REVENUE MANAGEMENT

### Big Idea

Founded in 2015, XLR8 has designed its Revenue Management System, a software program used to predict daily, monthly and yearly occupation for hotels, with tools and reports that help optimise rates and the number of rooms available, while maximising revenue growth. It provides a clear picture of current and future sales, based on historical data and forecasts (using Artificial Intelligence), which hotels can then use to analyse market behaviour patterns and take timely action to improve their results in the short, medium and long term.

XLR8<sup>RM</sup>  
ACCELERATING YOUR REVENUE MANAGEMENT ENERGY



### Sector

Enterprise

### Team

[José Almeida](#) - CEO

# Portugal Ventures

GROWING GLOBAL

GRUPO **BP**

## Join our Entrepreneurial and Business Community

Send us a message to [contact@portugalventures.pt](mailto:contact@portugalventures.pt)  
or fill out the form to schedule a meeting with us:



[contact form]

### LISBON OFFICE

Edifício Arcis, Rua Ivone Silva, 6, 12.º  
1050-124, Lisboa, Portugal  
P: +351 211 589 100



### PORTO OFFICE

Av. Dr. Antunes Guimarães, 103  
4100-079, Porto, Portugal  
P: +351 226 165 390



PortugalVentures

[portugalventures.pt](http://portugalventures.pt)